

ACU-X20-N3

Features

- Field replaceable
- HW version: 0001 / SW version: 6.54.0
- Compliant with AISG v2.0 and 3GPP
- 2x8 Pin Connector



ELECTRICAL SPECIFICATIONS

Protocol	---	Match 3GPP B / AISG v2.0
Power Supply	V	10 ~ 30 VDC (6 Pin)
Power Consumption	Watts	< 2 W (Idle Power), < 13 W (Active Power)
Connector(s)	---	2 x 8 Pin Connector (IEC60130-9) According to AISG: Male is Input, Female is Output (Male / Female can be Input and Output)
Hardware Interface	---	RS485 A/B (5 Pin, 3 Pin), Power Supply (1 Pin, 6 Pin), DC Loop (7 Pin)
Adjustment Time (Full Range)	Seconds	10 ~ 120 (Typical 40S, depends different antenna)
Lightning Protection Rating	---	8/20uS Differential Mode 5KA, Common Mode 5KA

MECHANICAL SPECIFICATIONS

Operating Temperature Range	degrees	-40° to +70° C (-40° to + 158° F)
Protection Class	---	IP55, with antenna test
Housing Material	---	Housing: Aluminum (Electrophoresis), Upper Cover / Bottom Cover: Zinc Alloy (Trivalent Chromium Plating)
Weight	g (lbs)	610 (1.34)
Dimensions	mm (in)	124.5 x 138 x 29.2 (4.9 x 5.4 x 1.1) Not including two end connectors

Quoted performance parameters are provided to offer typical, peak or range values only and may vary as a result of normal testing, manufacturing and operational conditions. Extreme operational conditions and/or stress on structural supports is beyond our control. Such conditions may result in damage to this product. Improvements to products may be made without notice.

ACU-X20-N3

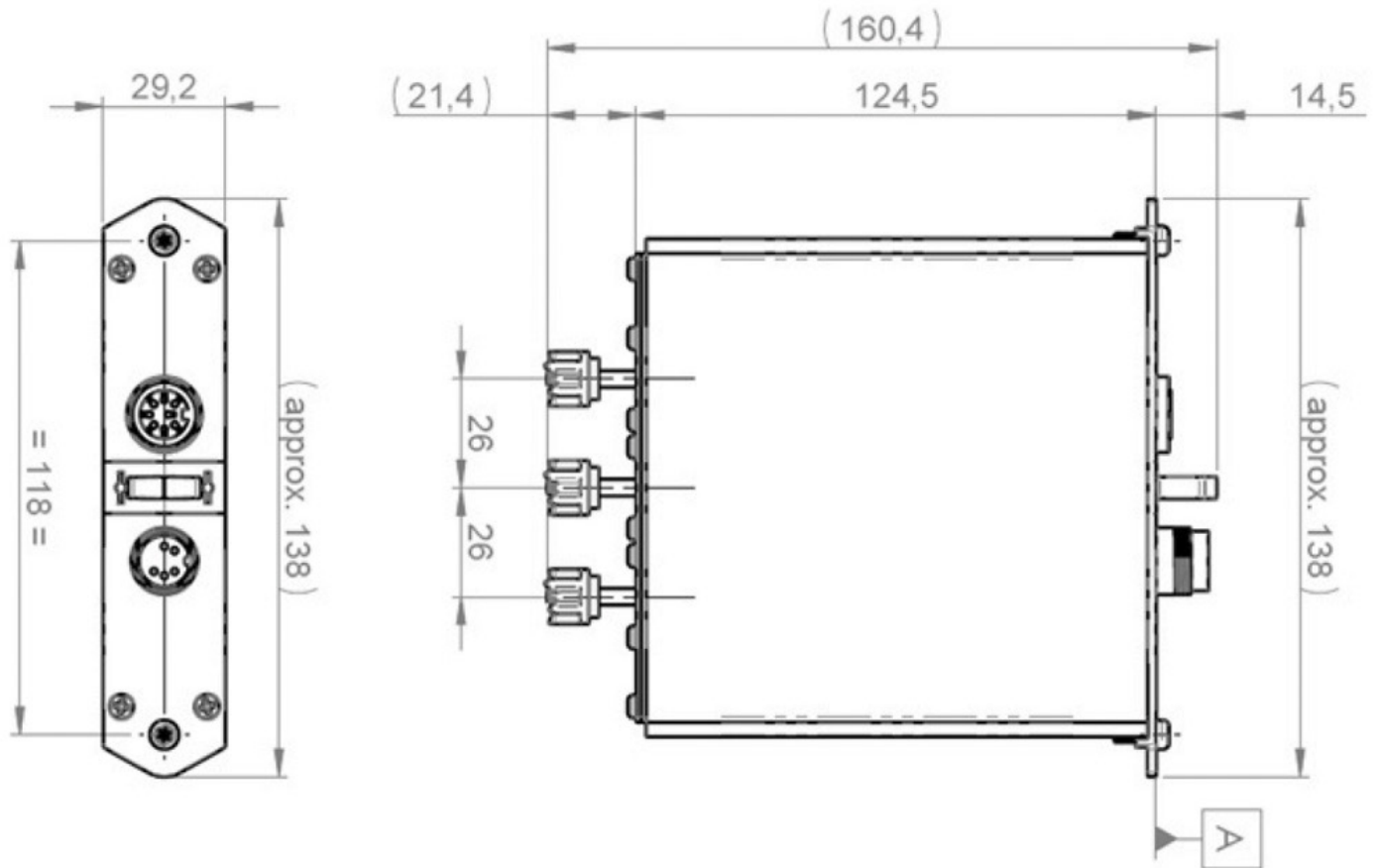

NOTES

This data is provisional and subject to changes.