

4U4MT360X06F_{xy}s0

Features

- 5G Pseudo Omni configuration with 16 connectors
- Ideal for Small Cell / DAS applications
- This antenna meets the requirements of the U-NII
- Available for order with a grey, brown or black radome



PRODUCT OVERVIEW	Frequency Range (MHz)	MID BAND (4x) 1695-2700				CBRS BAND (2x) 3550-3700		LAA BAND (2x) 5150-5925	
	Array	■ Y1	■ Y2	■ Y3	■ Y4	■ P1	■ P2	■ O1	■ O2
	Connector	8 PORTS				4 PORTS		4 PORTS	
	Polarization	XPOL				XPOL		XPOL	
	Azimuth Beamwidth (avg)	360°				360°		360°	
	Electrical Downtilt	2°, 4°, 6°				0°		0°	
	Configuration	OMNI CONFIGURATION							
	Connector Type	(16x) 4.3-10 FEMALE CONNECTORS							
	Dimensions	610 x Ø371 mm (24.0 x Ø14.6 in)							
	Radome Color Options	GREY, BROWN or BLACK							

ELECTRICAL SPECIFICATIONS

Mid Band

■ Y1 ■ Y2 ■ Y3 ■ Y4

Frequency Range	MHz	(4x) 1695-2700 MHz				
Frequency Sub-Range	MHz	1695-1880 MHz	1850-1990 MHz	1920-2200 MHz	2300-2700 MHz	
Polarization	---	(4x) ±45°				
Gain	BASTA	dBi	9.1 ± 0.5 dBi	8.9 ± 0.4 dBi	9.1 ± 0.7	9.6 ± 0.6
	MAX	dBi	9.6	9.3	9.8	10.2
Azimuth Beamwidth (3 dB)	degrees	360°	360°	360°	360°	
Elevation Beamwidth (3 dB)	degrees	23.4° ± 4.2°	21.7° ± 4.3°	20.9° ± 4.3°	17.1° ± 3.2°	
Electrical Downtilt	degrees	(x) 2°, 4°, 6°				
Impedance	Ohms	50Ω				
VSWR	---	≤ 1.5:1				
Passive Intermodulation 3rd Order for 2x20 W Carriers	dBc	< -153				
Upper Sidelobe Suppression	dB	> 14				
Isolation	Intraband	dB	25			
	Interband	dB	28			
Input Power	Watts	300W				

Quoted performance parameters are provided to offer typical, peak or range values only and may vary as a result of normal testing, manufacturing and operational conditions. Extreme operational conditions and/or stress on structural supports is beyond our control. Such conditions may result in damage to this product. Improvements to products may be made without notice.

4U4MT360X06F_{xy}s0

ELECTRICAL SPECIFICATIONS CBR5 Band

■ P1 ■ P2

Frequency Range	MHz	(2x) 3550-3700	
Polarization	---	(2x) ±45°	
Gain	BASTA	dBi	5.2 ± 0.5
	MAX	dBi	5.7
Azimuth Beamwidth (3 dB)	degrees	360°	
Elevation Beamwidth (3 dB)	degrees	37.1° ± 10.6°	
Electrical Downtilt	degrees	(y) 0°	
Impedance	Ohms	50Ω	
VSWR	---	≤ 1.5:1	
Passive Intermodulation 3rd Order for 2x20 W Carriers	dBc	N/A	
Upper Sidelobe Suppression	dB	N/A	
Isolation	Intraband	dB	25
	Interband	dB	28
Input Power	Watts	100W	

ELECTRICAL SPECIFICATIONS LAA Band

■ O1 ■ O2

Frequency Range	MHz	(2x) 5150-5925	
Polarization	---	(2x) ±45°	
Gain	BASTA	dBi	4.4 ± 0.6
	MAX	dBi	5.0
Azimuth Beamwidth (3 dB)	degrees	360°	
Elevation Beamwidth (3 dB)	degrees	22.9 ± 5.1°	
Electrical Downtilt	degrees	(y) 0°	
Impedance	Ohms	50Ω	
VSWR	---	≤ 1.5:1	
Passive Intermodulation 3rd Order for 2x20 W Carriers	dBc	N/A	
Upper Sidelobe Suppression	dB	> 13 dB	
Isolation	Intraband	dB	25
	Interband	dB	28
Input Power	Watts	50W	
U-NII Compliant	---	Yes	

Quoted performance parameters are provided to offer typical, peak or range values only and may vary as a result of normal testing, manufacturing and operational conditions. Extreme operational conditions and/or stress on structural supports is beyond our control. Such conditions may result in damage to this product. Improvements to products may be made without notice.

4U4MT360X06F_{xy}s0

MECHANICAL SPECIFICATIONS

Antenna	Height	mm (in)	610 (24.0)
	Diameter	mm (in)	371 (14.6)
Net Weight - Antenna Only		kg (lbs)	12.7 (28)
Windload	Calculation	km/h (mph)	160 (100)
	Frontal	N (lbf)	191 (43)
Survival Wind Speed		km/h (mph)	241 (150)
Wind Area		m ² (ft ²)	0.22 (2.4)
Volume		m ³ (ft ³)	0.07 (2.3)
Connector	Type	---	4.3-10 Female
	Quantity	---	16
	Position	---	Bottom
Radome Color		---	Grey (Pantone 420 C), Brown (Pantone 476 C), Black (RAL 9011)
Lightning Protection (Grounding Type)		---	Direct Ground

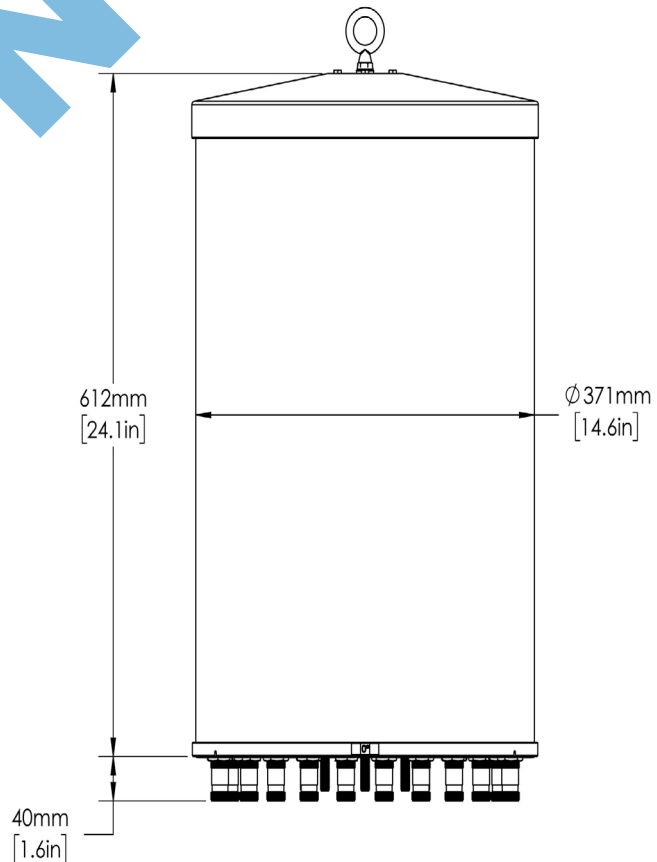

Quoted performance parameters are provided to offer typical, peak or range values only and may vary as a result of normal testing, manufacturing and operational conditions. Extreme operational conditions and/or stress on structural supports is beyond our control. Such conditions may result in damage to this product. Improvements to products may be made without notice.

4U4MT360X06F_{xys0}

ARRAY LAYOUT Topology

FREQUENCY	ARRAY	CONNECTOR	CONNECTOR TYPE
MID BAND	1695-2700	■ Y1	1-2 (2x) 4.3-10 Female
	1695-2700	■ Y2	3-4 (2x) 4.3-10 Female
	1695-2700	■ Y3	5-6 (2x) 4.3-10 Female
	1695-2700	■ Y4	7-8 (2x) 4.3-10 Female
CBRS BAND	3550-3700	■ P1	9-10 (2x) 4.3-10 Female
	3550-3700	■ P2	11-12 (2x) 4.3-10 Female
LAA BAND	5150-5925	■ O1	13-14 (2x) 4.3-10 Female
	5150-5925	■ O2	15-16 (2x) 4.310 Female

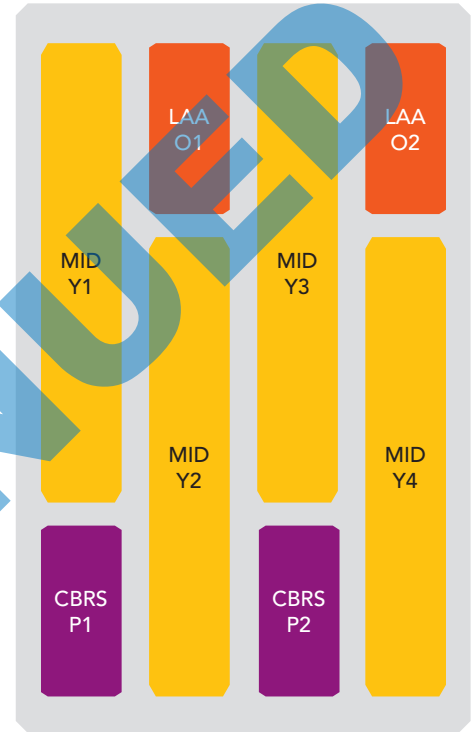

The illustration is not shown to scale.

DISCONTINUED

Quoted performance parameters are provided to offer typical, peak or range values only and may vary as a result of normal testing, manufacturing and operational conditions. Extreme operational conditions and/or stress on structural supports is beyond our control. Such conditions may result in damage to this product. Improvements to products may be made without notice.

4U4MT360X06F_{xy}s0

BOTTOM VIEW - LABELING

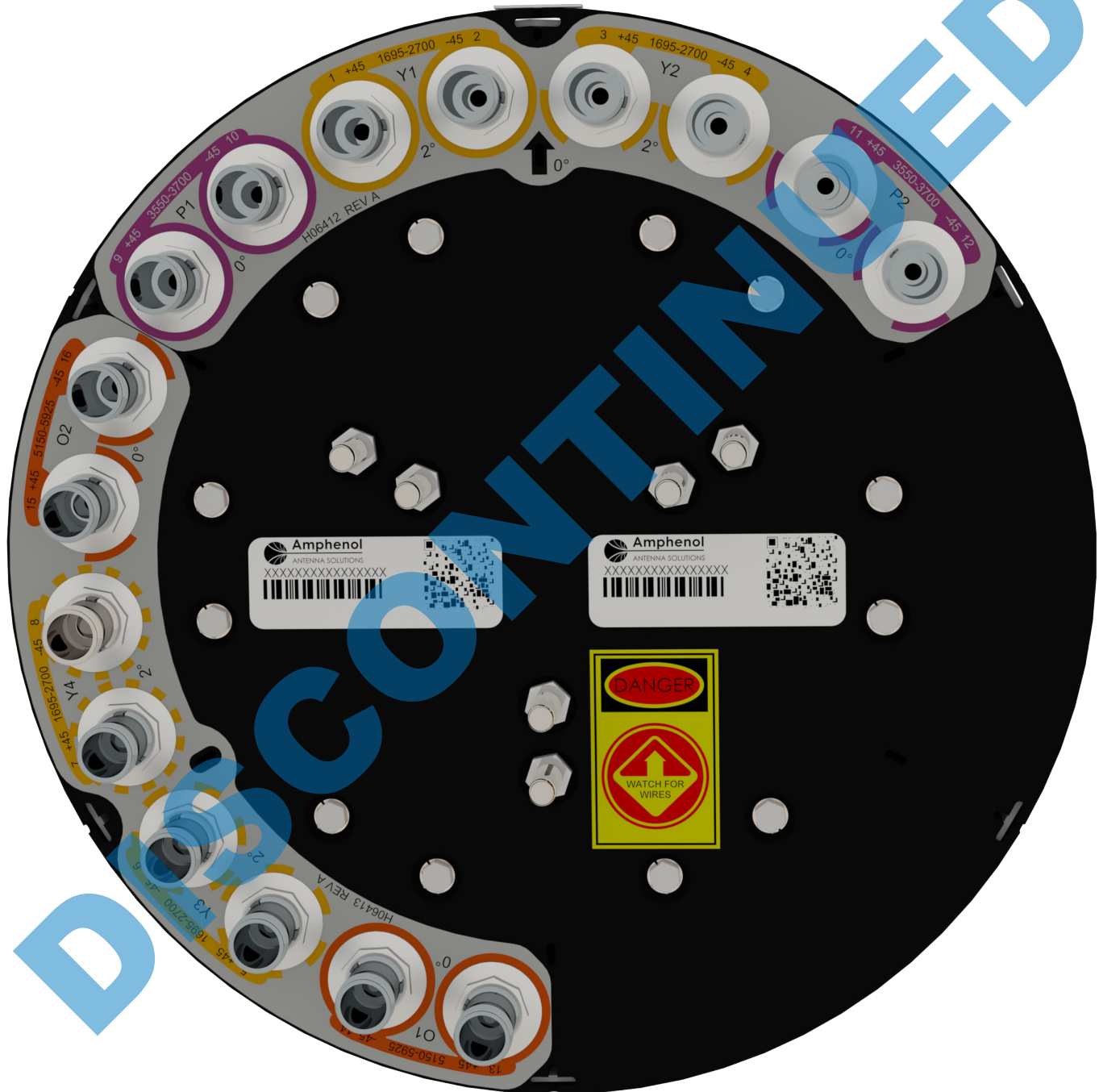

Quoted performance parameters are provided to offer typical, peak or range values only and may vary as a result of normal testing, manufacturing and operational conditions. Extreme operational conditions and/or stress on structural supports is beyond our control. Such conditions may result in damage to this product. Improvements to products may be made without notice.

4U4MT360X06F_{xy}s0

BOTTOM VIEW - CONNECTOR DIAGRAM

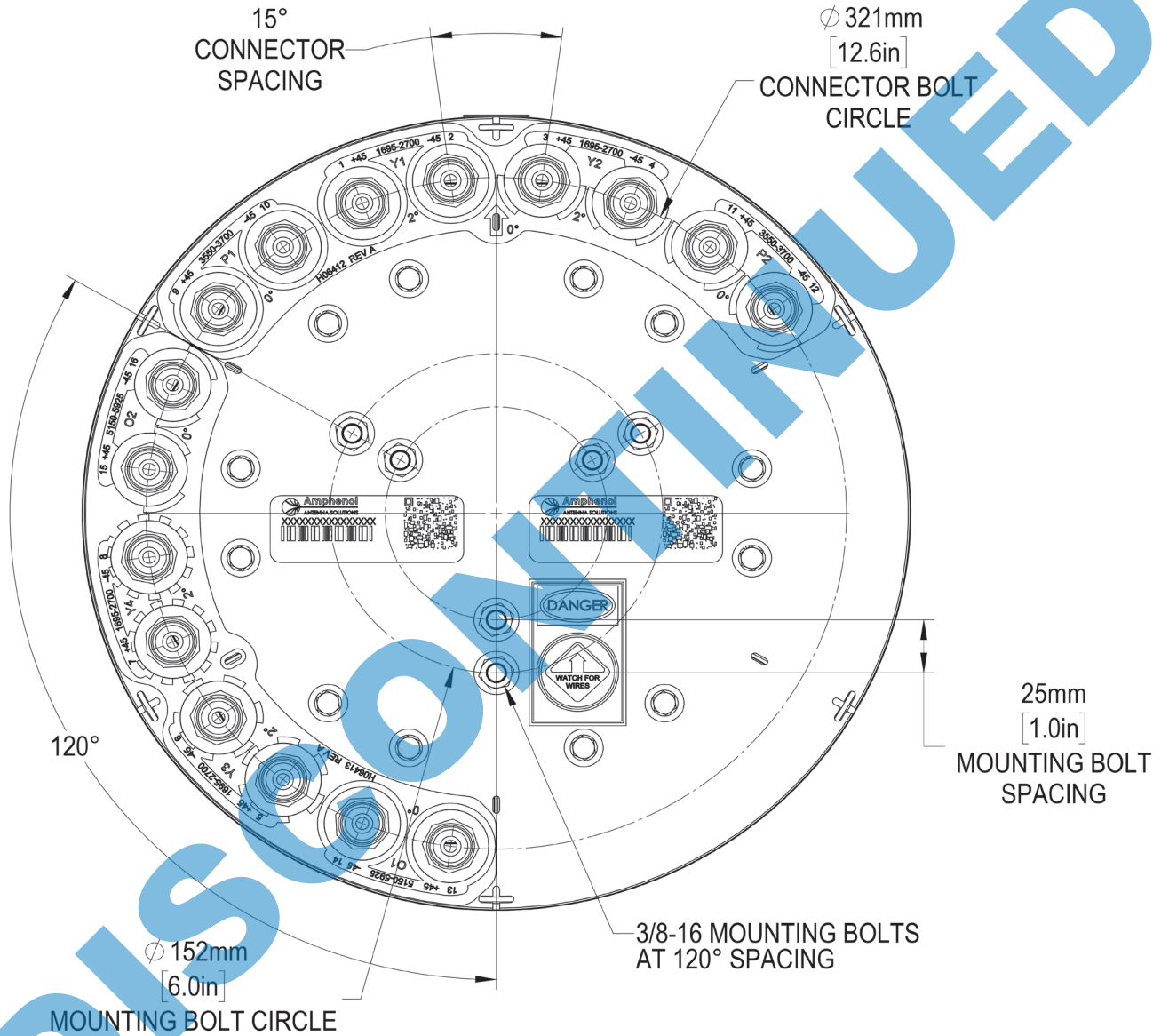

INSTALLATION Please read all installation notes before installing this product.



Always attach the antenna using all mounting points.

Do not install the antenna with the connectors facing upwards.

Quoted performance parameters are provided to offer typical, peak or range values only and may vary as a result of normal testing, manufacturing and operational conditions. Extreme operational conditions and/or stress on structural supports is beyond our control. Such conditions may result in damage to this product. Improvements to products may be made without notice.

4U4MT360X06F_{xy}s0

MOUNTING KITS Select from the following mounting options when ordering. Mounting kits for canister antennas are ordered as a separate line item.

MODEL NUMBER		DESCRIPTION
CWT-MKS-SIDE		SIDE MOUNTING BRACKET KIT FOR CANISTER ANTENNA
CWT-MKS-TOP		TOP MOUNTING BRACKET KIT FOR CANISTER ANTENNA
WB3X-MKS-01		UTILITY POLE MOUNTING BRACKET KIT FOR CANISTER ANTENNA
CWT-MKS-BASE-xx		WIDE DIAMETER POLE TOP MOUNTING BRACKET KIT FOR CANISTER ANTENNA. AVAILABLE IN BROWN, BLACK AND GREY TO MATCH ANTENNA RADOME AND/OR MOUNTING STRUCTURE.

Quoted performance parameters are provided to offer typical, peak or range values only and may vary as a result of normal testing, manufacturing and operational conditions. Extreme operational conditions and/or stress on structural supports is beyond our control. Such conditions may result in damage to this product. Improvements to products may be made without notice.

4U4MT360X06F_{xy}s0

HOW TO READ THE MODEL NUMBER

Each letter and number has meaning.

NUMBER OF BANDS and OPERATING FREQUENCY			PATTERN TYPE	AZIMUTH BEAMWIDTH	POLARIZATION	LENGTH	TILT TYPE	TILT OPTIONS	CONNECTOR TYPE	VARIATION	RADOME COLOR
4U	4M		T	360	X	06	F	xy	s	0	BK BR
(4x) 1695- 2700	(2x) 3550- 3700	(2x) 5150- 5925	Tri-Sector	360°	XPOL	0.6 meters	Fixed Tilt	These letters are placeholders for fixed tilt options. Refer to Electrical Specifications for available tilt options.	4.3-10 Connector	Original Variation	BK indicates a Black radome. BR indicates a Brown radome. The default radome color is Grey. No letters are required for a Grey radome.

ORDERING OPTIONS

Select from the following ordering options

SELECT RADOME COLOR	SELECT DEGREE OF ELECTRICAL DOWNTILT FOR EACH BAND			ORDER MODEL NUMBER
	MID BAND	CBRS BAND	LAA BAND	
Grey Pantone 420 C	2°	0°	0°	4U4MT360X06F20s0
	4°	0°	0°	4U4MT360X06F40s0
	6°	0°	0°	4U4MT360X06F60s0
	Y1 & Y2 = 2°; Y3 & Y4 = 6°	0°	0°	4U4MT360X06FAAs0
	Y1 & Y2 = 2°; Y3 & Y4 = 4°	0°	0°	4U4MT360X06FBBs0
	Y1 & Y2 = 4°; Y3 & Y4 = 6°	0°	0°	4U4MT360X06FCCs0
Brown Pantone 476 C	2°	0°	0°	4U4MT360X06F20s0BR
	4°	0°	0°	4U4MT360X06F40s0BR
	6°	0°	0°	4U4MT360X06F60s0BR
	Y1 & Y2 = 2°; Y3 & Y4 = 6°	0°	0°	4U4MT360X06FAAs0BR
	Y1 & Y2 = 2°; Y3 & Y4 = 4°	0°	0°	4U4MT360X06FBBs0BR
	Y1 & Y2 = 4°; Y3 & Y4 = 6°	0°	0°	4U4MT360X06FCCs0BR
Black RAL 9011	2°	0°	0°	4U4MT360X06F20s0BK
	4°	0°	0°	4U4MT360X06F40s0BK
	6°	0°	0°	4U4MT360X06F60s0BK
	Y1 & Y2 = 2°; Y3 & Y4 = 6°	0°	0°	4U4MT360X06FAAs0BK
	Y1 & Y2 = 2°; Y3 & Y4 = 4°	0°	0°	4U4MT360X06FBBs0BK
	Y1 & Y2 = 4°; Y3 & Y4 = 6°	0°	0°	4U4MT360X06FCCs0BK

Quoted performance parameters are provided to offer typical, peak or range values only and may vary as a result of normal testing, manufacturing and operational conditions. Extreme operational conditions and/or stress on structural supports is beyond our control. Such conditions may result in damage to this product. Improvements to products may be made without notice.

OMNI | 24 IN | FIXED TILT

4U4MT360X06F_{xys}0

1800 MHz ———
1900 MHz ———
2100 MHz ———
2600 MHz ———

Y1, 2° TILT

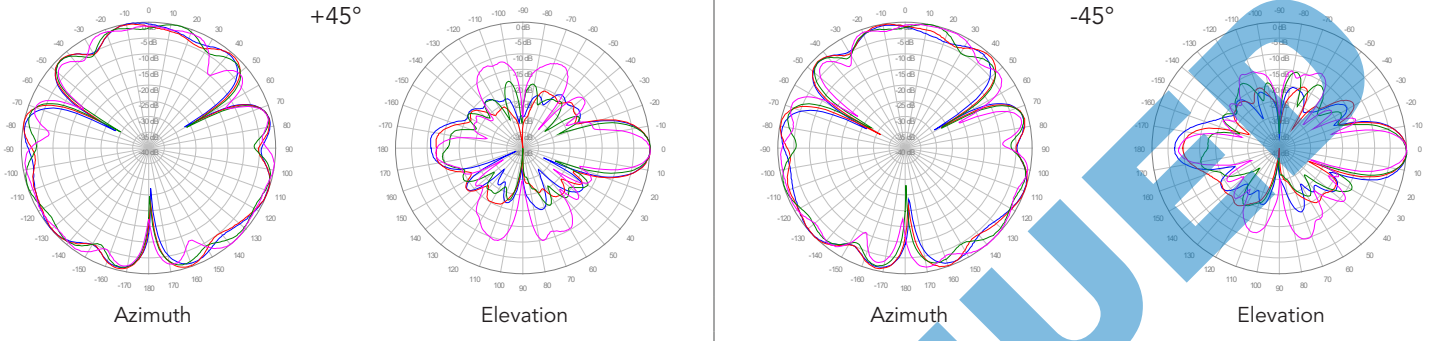

Y2, 2° TILT

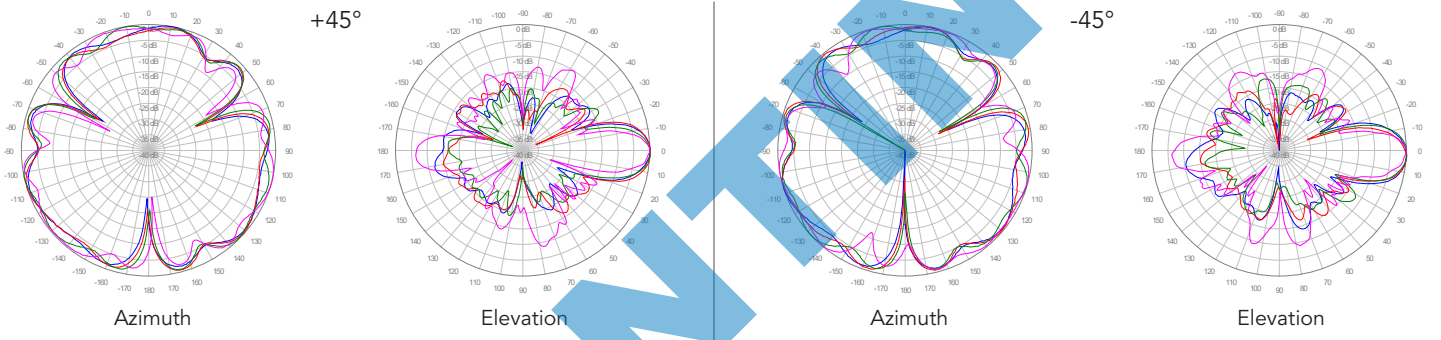

Y3, 2° TILT

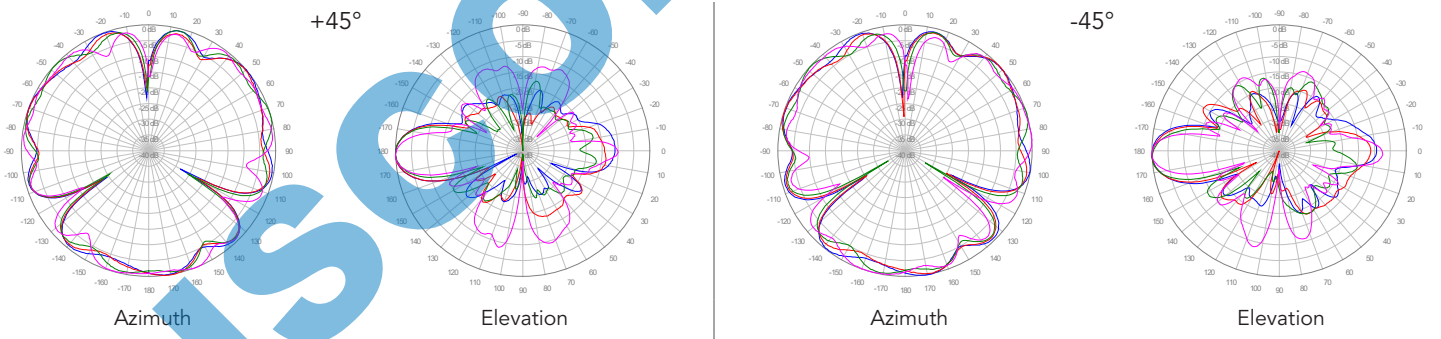

Y4, 2° TILT

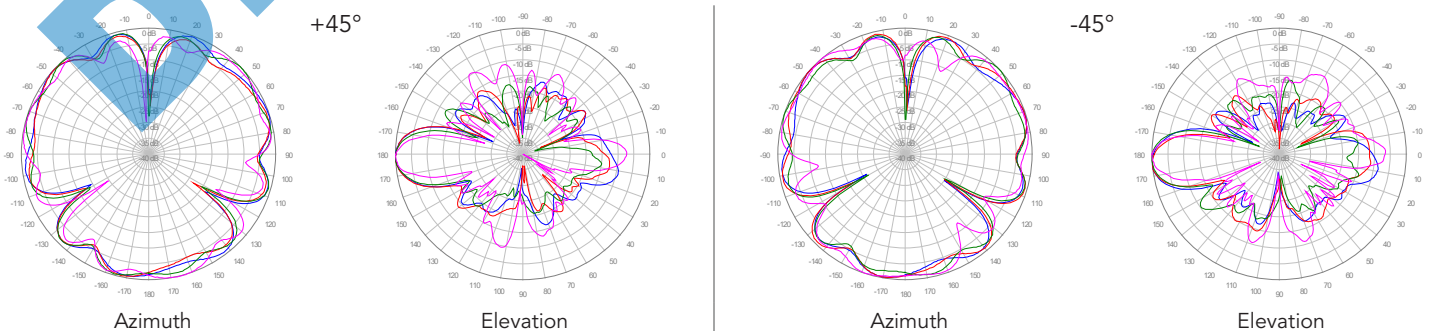

Quoted performance parameters are provided to offer typical, peak or range values only and may vary as a result of normal testing, manufacturing and operational conditions. Extreme operational conditions and/or stress on structural supports is beyond our control. Such conditions may result in damage to this product. Improvements to products may be made without notice.

OMNI | 24 IN | FIXED TILT

4U4MT360X06F_{xy}s0

1800 MHz ———
1900 MHz ———
2100 MHz ———
2600 MHz ———

Y1, 4° TILT

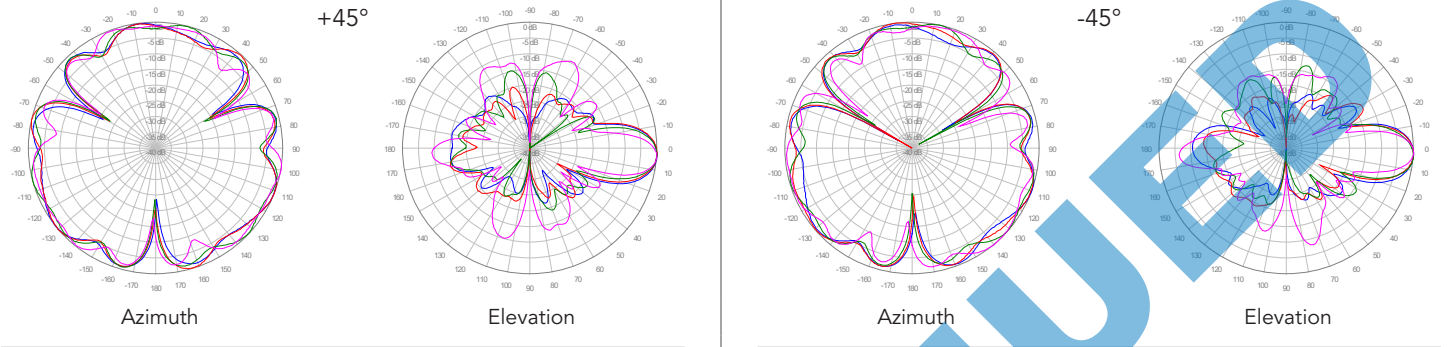

Y2, 4° TILT

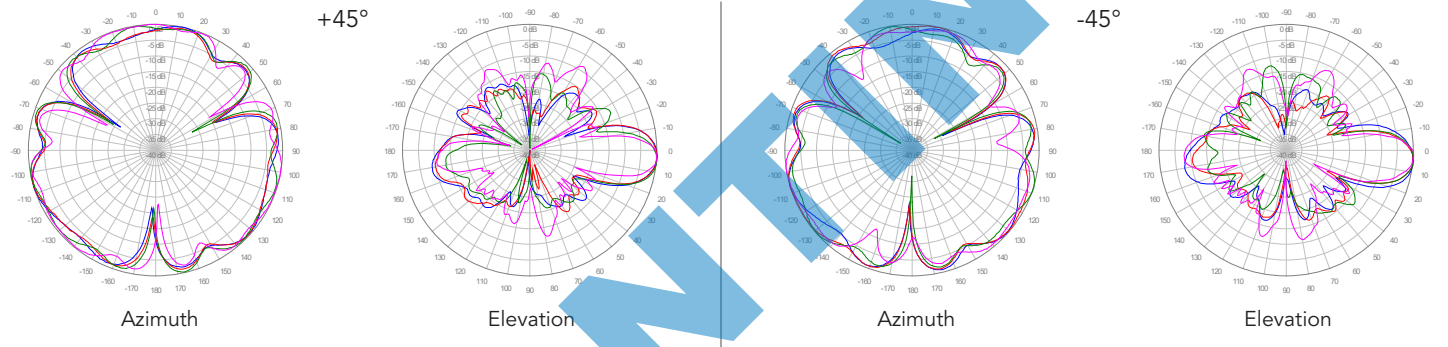

Y3, 4° TILT

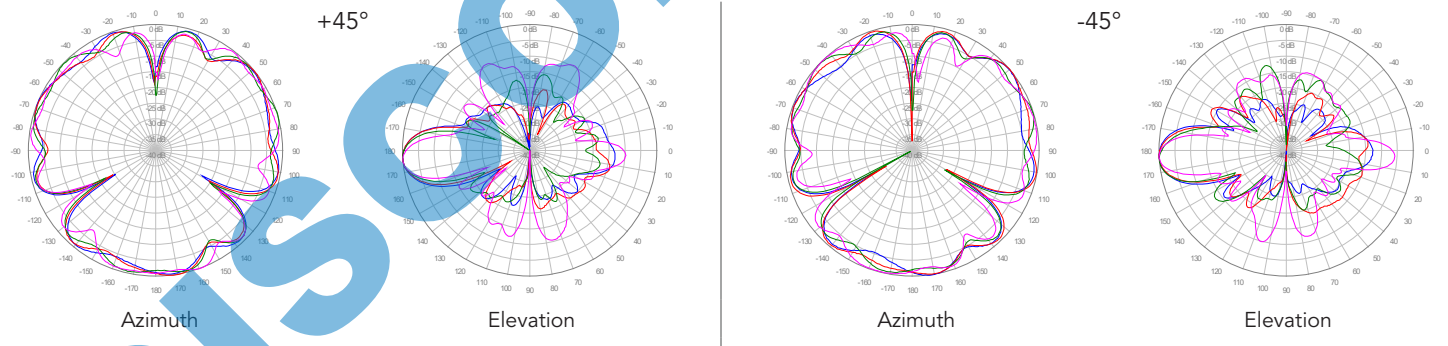

Y4, 4° TILT

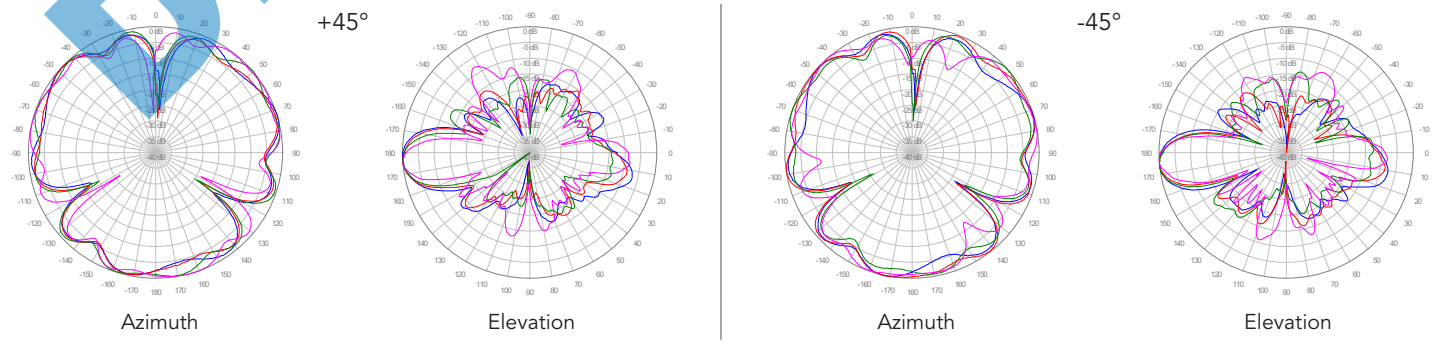

Quoted performance parameters are provided to offer typical, peak or range values only and may vary as a result of normal testing, manufacturing and operational conditions. Extreme operational conditions and/or stress on structural supports is beyond our control. Such conditions may result in damage to this product. Improvements to products may be made without notice.

OMNI | 24 IN | FIXED TILT

4U4MT360X06F_{xy}s0

1800 MHz ———
1900 MHz ———
2100 MHz ———
2600 MHz ———

Y1, 6° TILT

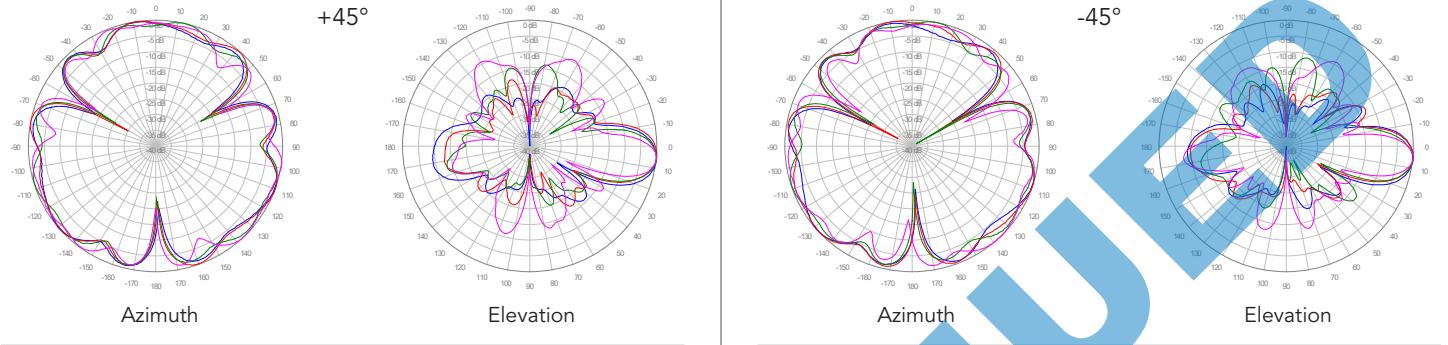

Y2, 6° TILT

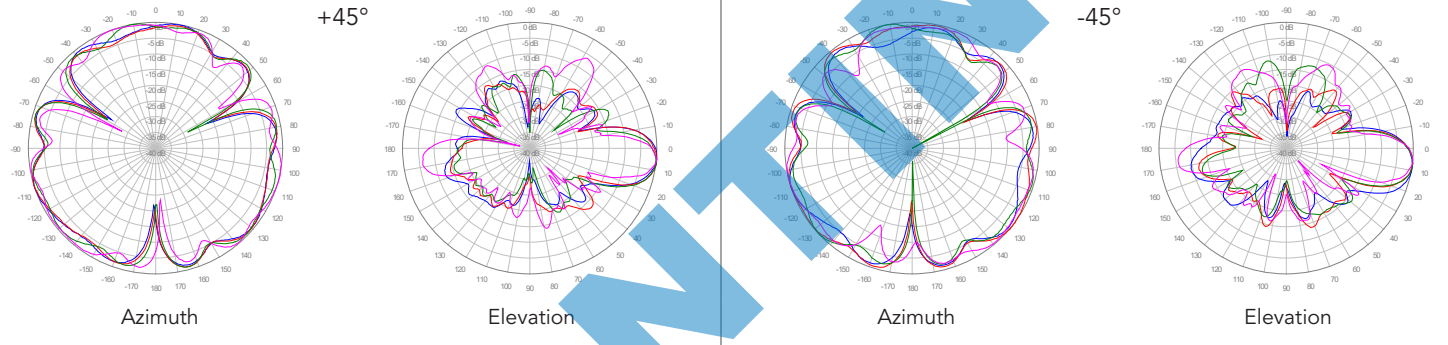

Y3, 6° TILT

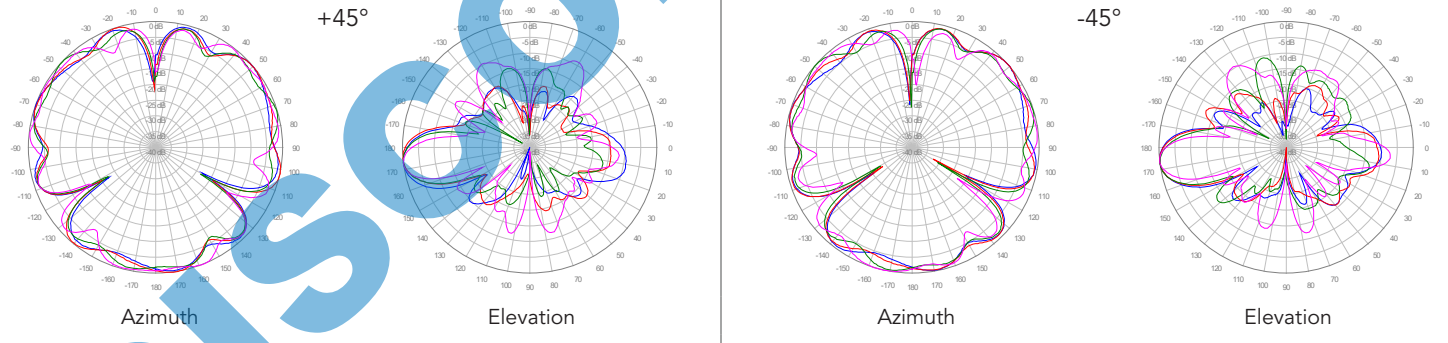

Y4, 6° TILT

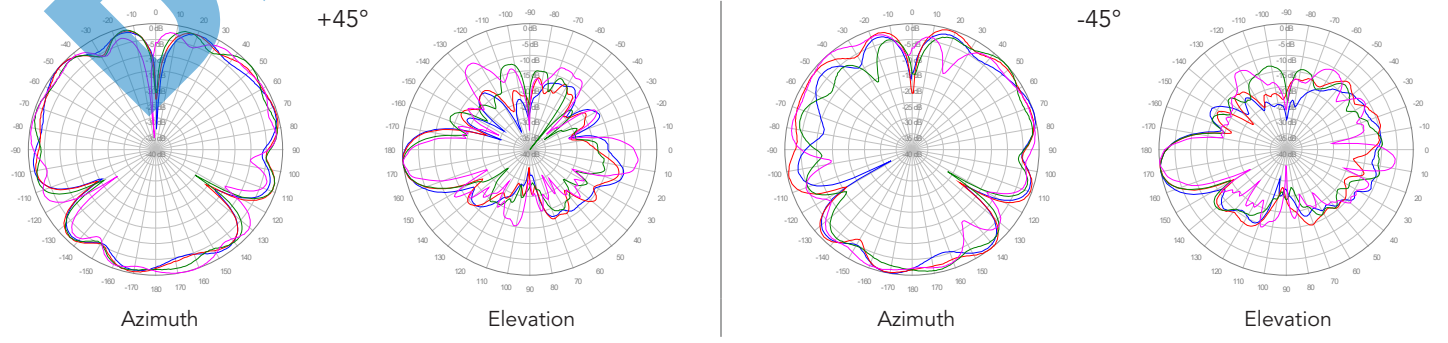

Quoted performance parameters are provided to offer typical, peak or range values only and may vary as a result of normal testing, manufacturing and operational conditions. Extreme operational conditions and/or stress on structural supports is beyond our control. Such conditions may result in damage to this product. Improvements to products may be made without notice.

4U4MT360X06F_xys0

■ P1, 0° TILT

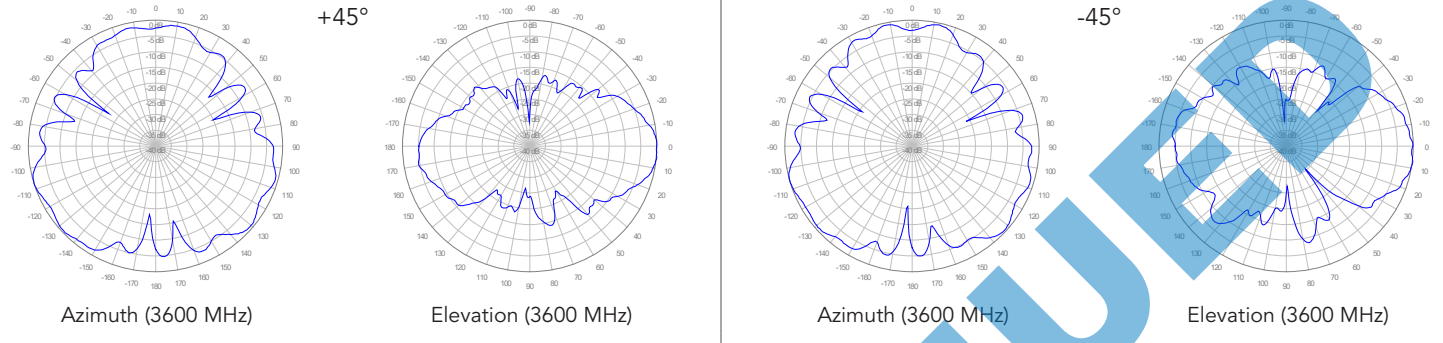

■ P2, 0° TILT

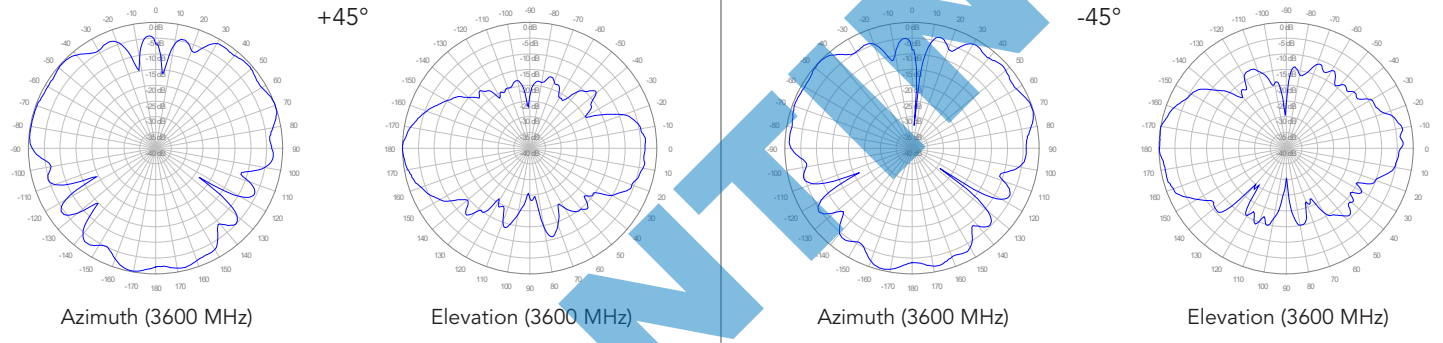

■ O1, 0° TILT

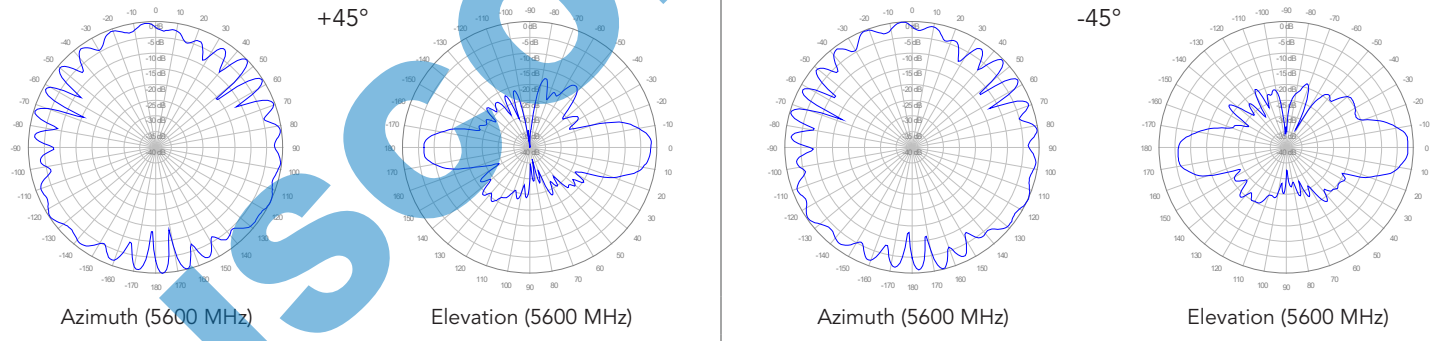

■ O2, 0° TILT

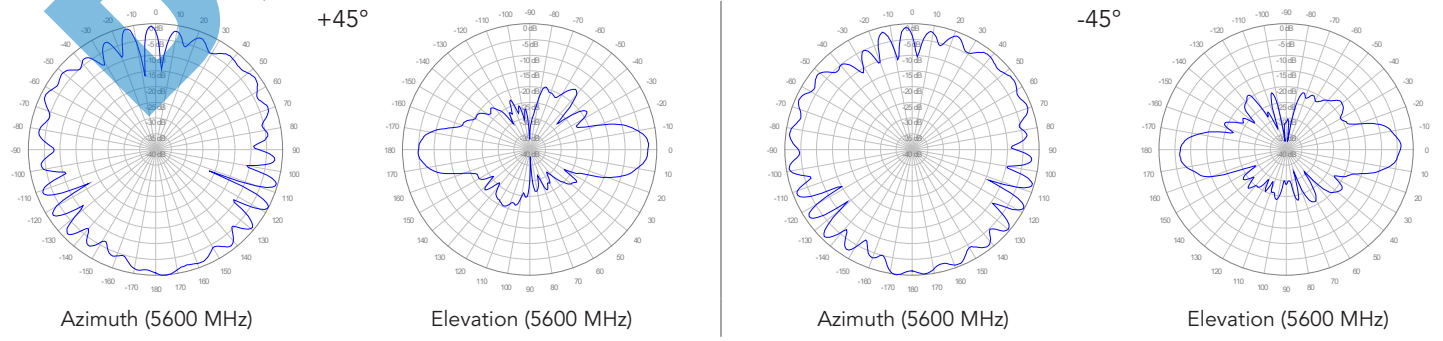

Quoted performance parameters are provided to offer typical, peak or range values only and may vary as a result of normal testing, manufacturing and operational conditions. Extreme operational conditions and/or stress on structural supports is beyond our control. Such conditions may result in damage to this product. Improvements to products may be made without notice.