

## HEX334CW0000x

TRI BAND | HEX PORT | PANEL ANTENNA | XXX-POL | 33° / 33° / 33° | 15.3 / 18.0 / 18.0 DBI | VARIABLE TILT

### Features

- AWS-3 Ready
- 4x4 MIMO high band compatible
- Patented internal RET actuator adds no additional length to the antenna
- Can be ordered with a Multi-Device Dual Unit (MDDU) with two separate inputs for independent control of each band

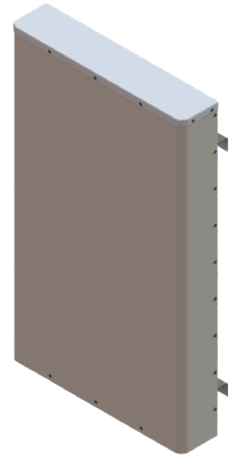

### Connector Description

The antenna has six (6) connectors located at the bottom, each marked with a colored ring.

Low Band	696-960 MHz	Red Rings		(2x) 7/16-DIN Female
High Band #1	1695-2180 MHz	Blue Rings		(2x) 7/16-DIN Female
High Band #2	1695-2180 MHz	White Rings		(2x) 7/16-DIN Female



Electrical Characteristics	Low Band		High Band #1 and #2		
	696-960 MHz		(2x) 1695-2180 MHz		
Frequency Bands (MHz)	696-806	806-960	1695-1850	1850-1990	2100-2180
Polarization	±45°		(2x) ±45°		
Horizontal Beamwidth	35°	30°	38°	35°	30°
Vertical Beamwidth	21.0°	17.5°	9.0°	8.3°	7.6°
Gain	14.3 dBi	15.3 dBi	17.0 dBi	17.5 dBi	18.0 dBi
Electrical Downtilt	0-14°		0-10°		
Impedance	50Ω		50Ω		
VSWR	< 1.5:1		< 1.5:1		
Upper Sidelobe Suppression	> 16 dB Typical		> 18 dB Typical		
Front-to-Back Ratio	> 25 dB		> 27 dB		
In-Band Isolation	> 19 dB		> 19 dB		
Isolation Between Ports	> 25 dB		> 25 dB		
IM3 (2x20W carrier)	< -153 dBc		< -153 dBc		
Input Power	(2x) 500 W		(4x) 250 W		
Diplexed	No				
Lightning Protection	Direct Ground				
Operating Temperature	-40° to +60° C (-40° to +140° F)				

### Mechanical Characteristics

Dimensions (Length x Width x Depth)		1228 x 724 x 153 mm	48.3 x 28.5 x 6.0 in
Weight	Antenna Only	28.3 kg	62.4 lbs
	Antenna with Mounting Bracket Kit <b>MKS09P04</b>	42.8 kg	94.4 lbs
Survival Wind Speed		241 km/hr	150 mph
Wind Loads (160 km/hr or 100 mph)	Front	1086 N	244 lbf
	Side	229 N	52 lbf

Quoted performance parameters are provided to offer typical, peak or range values only and may vary as a result of normal testing, manufacturing and operational conditions. Extreme operational conditions and/or stress on structural supports is beyond our control. Such conditions may result in damage to this product. Improvements to products may be made without notice.

HEX334CW0000x

TRI BAND | HEX PORT | PANEL ANTENNA | XXX-POL | 33° / 33° / 33° | 15.3 / 18.0 / 18.0 DBI | VARIABLE TILT

Electrical Downtilt Control		
Manual Electrical Tilt (MET) Control	Electrical downtilt for each band can be controlled separately. A colored knob at the end of the tilt indicator allows change of the tilt without need of a tool. The knob color is identical to the corresponding connector ring color. To access the knob, remove the cap by turning it counter-clockwise. It is re-installed by opposite rotation. <b>Do not remove the transparent cap(s) from the antenna.</b>	
Remote Electrical Tilt (RET) Control	Electrical downtilt for each band can be controlled separately. The remote control of the electrical tilt is managed by either a Multi-Device Control Unit (MDCU) or a Multi-Device Dual Unit (MDDU) inserted in the bottom of the antenna. A single actuator individually controls the tilt of each band (no need for daisy chain cables between the bands). This module does not add any additional length to the antenna. For RET control, the transparent caps must be in place and locked. The tilt angle indicators always remain visible and the antenna still has manual tilt control (manual override). <b>Do not remove the transparent cap(s) from the antenna.</b>	
RET Actuators (Units are Field Replaceable)	Multi-Device Control Unit (MDCU) An electronic module that allows the remote control of the electrical downtilt (RET) in Amphenol antennas with factory embedded motors. The MDCU is factory installed.	Multi-Device Dual Unit (MDDU) Allows two separate RET Controllers to independently drive the RETs in Amphenol antennas with factory installed motors (for antenna sharing). The MDDU is factory installed. Refer to Ordering Options for unique AISG port configurations
		 Port A      Port B
		Two separate inputs for independent control of each band

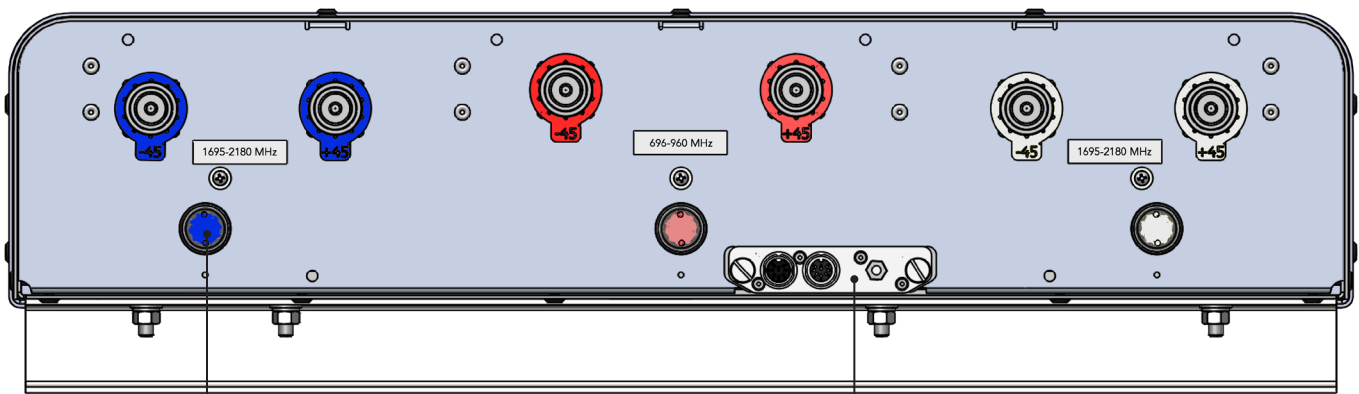

Tilt indicators covered by transparent caps. Knob colors are the same as the connectors.

Location of the MDCU or MDDU for RET Control (MDCU shown)



In order to operate RET control, the transparent caps covering the tilt adjustment indicators must be engaged and locked. Do not cut them from the antenna.

Quoted performance parameters are provided to offer typical, peak or range values only and may vary as a result of normal testing, manufacturing and operational conditions. Extreme operational conditions and/or stress on structural supports is beyond our control. Such conditions may result in damage to this product. Improvements to products may be made without notice.

HEX334CW0000x

TRI BAND | HEX PORT | PANEL ANTENNA | XXX-POL | 33° / 33° / 33° | 15.3 / 18.0 / 18.0 DBI | VARIABLE TILT

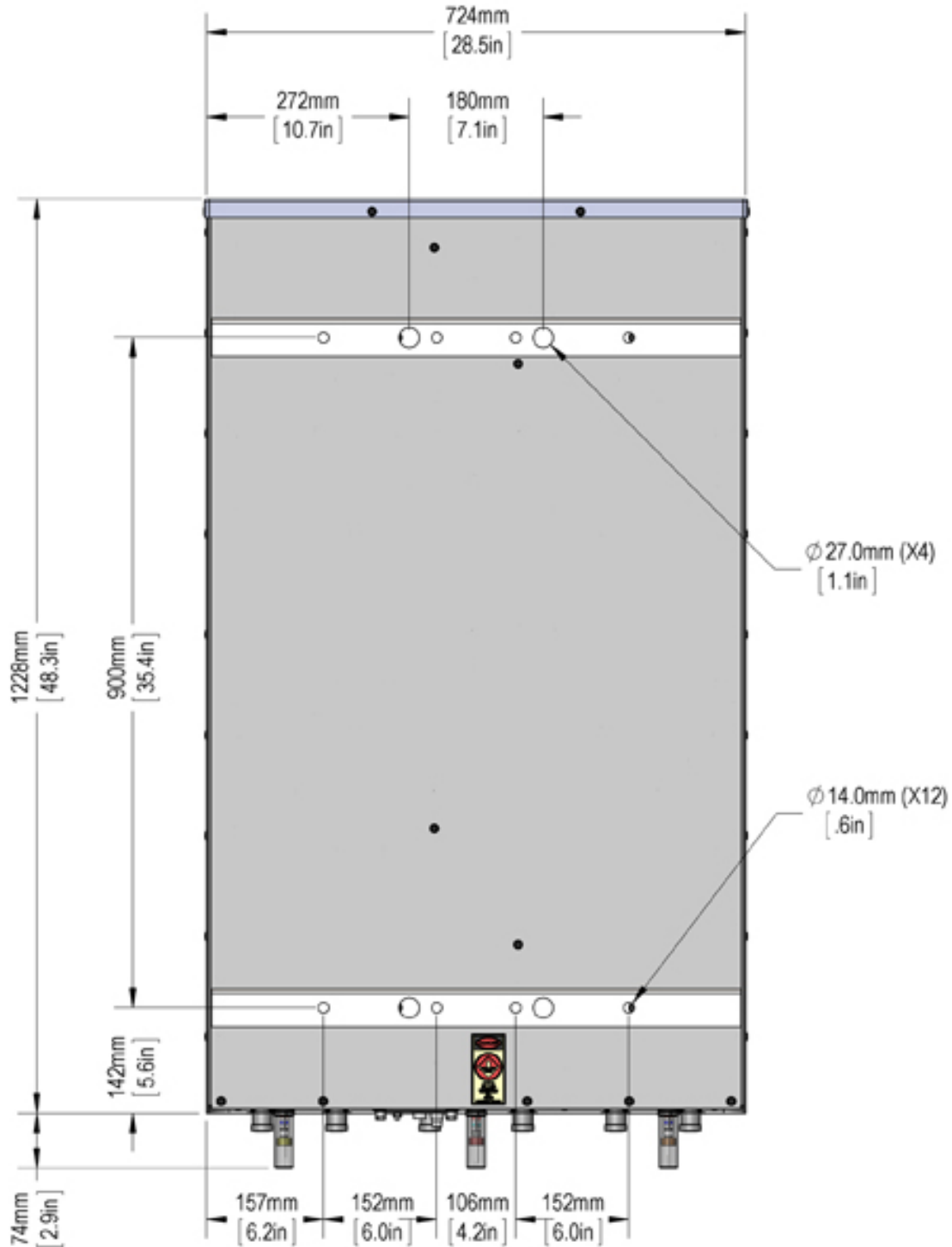

Quoted performance parameters are provided to offer typical, peak or range values only and may vary as a result of normal testing, manufacturing and operational conditions. Extreme operational conditions and/or stress on structural supports is beyond our control. Such conditions may result in damage to this product. Improvements to products may be made without notice.

HEX334CW0000x

TRI BAND | HEX PORT | PANEL ANTENNA | XXX-POL | 33° / 33° / 33° | 15.3 / 18.0 / 18.0 DBI | VARIABLE TILT

696-960 MHz

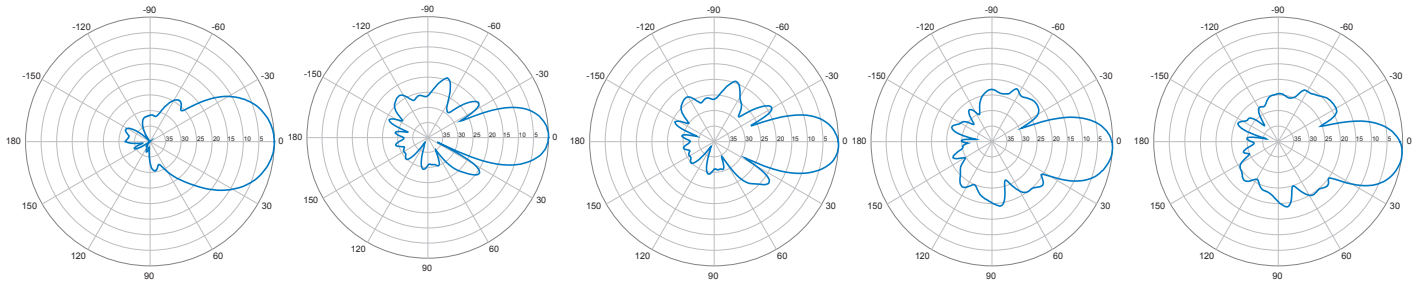

Horizontal | 750 MHz

0° | Vertical | 750 MHz

2° | Vertical | 750 MHz

4° | Vertical | 750 MHz

6° | Vertical | 750 MHz

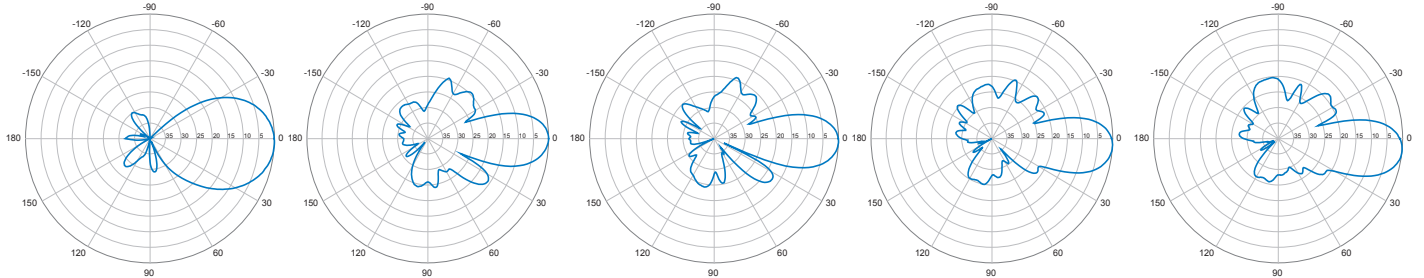

Horizontal | 850 MHz

0° | Vertical | 850 MHz

2° | Vertical | 850 MHz

4° | Vertical | 850 MHz

6° | Vertical | 850 MHz

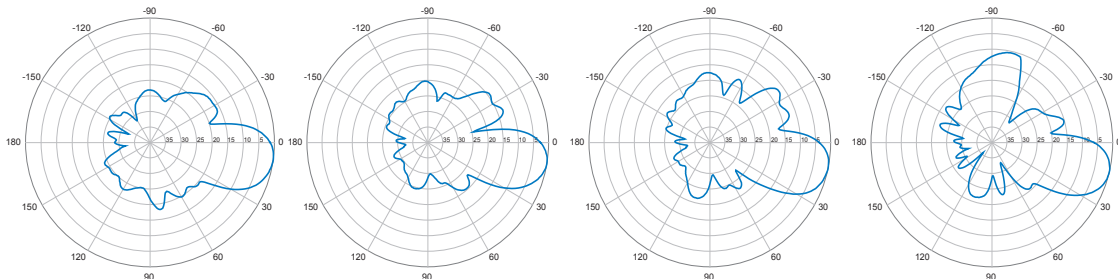

8° | Vertical | 750 MHz

10° | Vertical | 750 MHz

12° | Vertical | 750 MHz

14° | Vertical | 750 MHz

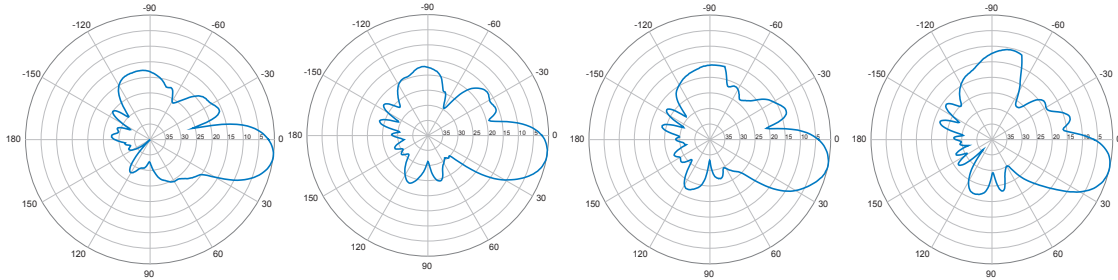

8° | Vertical | 850 MHz

10° | Vertical | 850 MHz

12° | Vertical | 850 MHz

14° | Vertical | 850 MHz

Quoted performance parameters are provided to offer typical, peak or range values only and may vary as a result of normal testing, manufacturing and operational conditions. Extreme operational conditions and/or stress on structural supports is beyond our control. Such conditions may result in damage to this product. Improvements to products may be made without notice.

HEX334CW0000x

TRI BAND | HEX PORT | PANEL ANTENNA | XXX-POL | 33° / 33° / 33° | 15.3 / 18.0 / 18.0 DBI | VARIABLE TILT

1695-2180 MHz

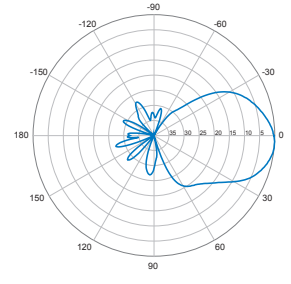
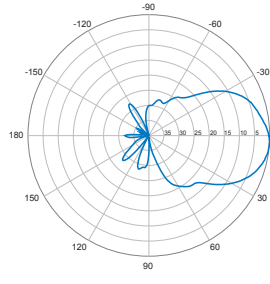
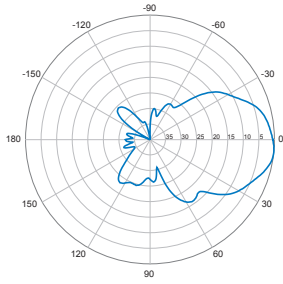

Horizontal | 1800 MHz

Horizontal | 1900 MHz

Horizontal | 2100 MHz

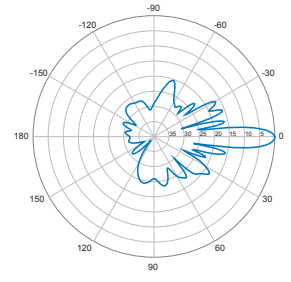
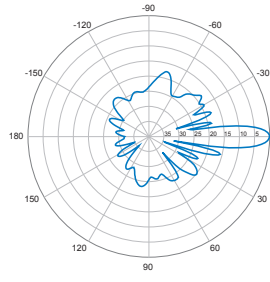
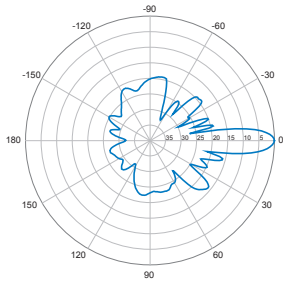

0° | Vertical | 1800 MHz

0° | Vertical | 1900 MHz

0° | Vertical | 2100 MHz

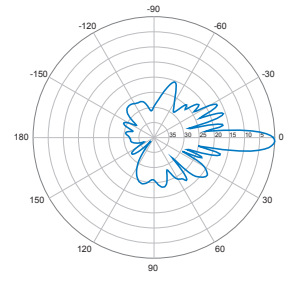
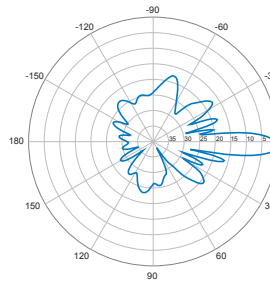
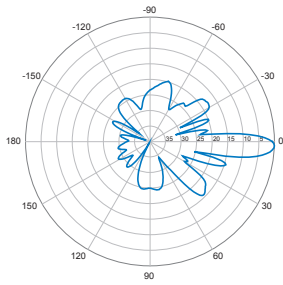

2° | Vertical | 1800 MHz

2° | Vertical | 1900 MHz

2° | Vertical | 2100 MHz

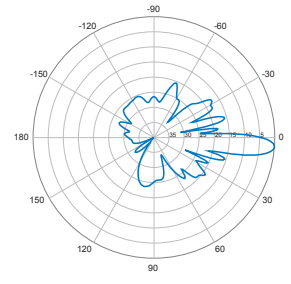
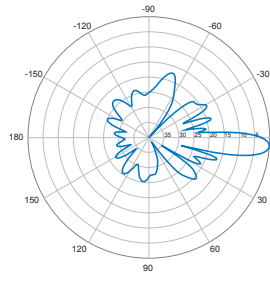
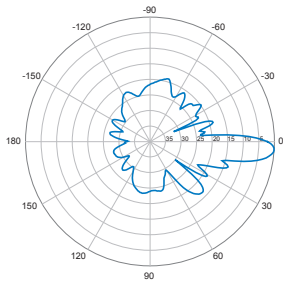

4° | Vertical | 1800 MHz

4° | Vertical | 1900 MHz

4° | Vertical | 2100 MHz

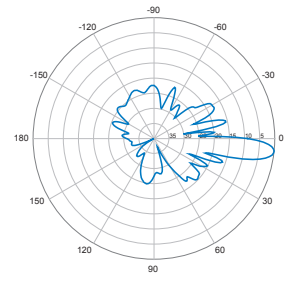
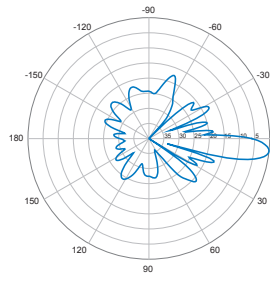
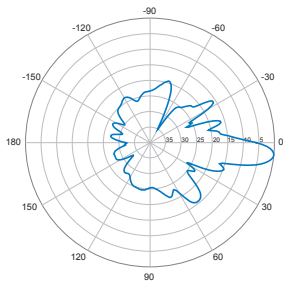

6° | Vertical | 1800 MHz

6° | Vertical | 1900 MHz

6° | Vertical | 2100 MHz

Quoted performance parameters are provided to offer typical, peak or range values only and may vary as a result of normal testing, manufacturing and operational conditions. Extreme operational conditions and/or stress on structural supports is beyond our control. Such conditions may result in damage to this product. Improvements to products may be made without notice.

HEX334CW0000x

TRI BAND | HEX PORT | PANEL ANTENNA | XXX-POL | 33° / 33° / 33° | 15.3 / 18.0 / 18.0 DBI | VARIABLE TILT

1695-2180 MHz

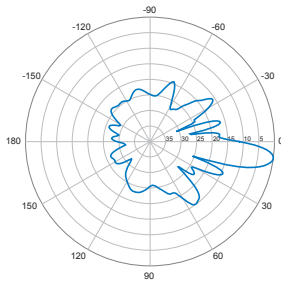

8° | Vertical | 1800 MHz

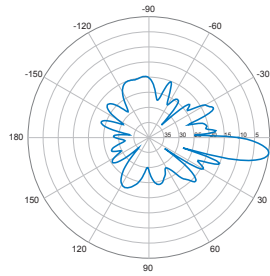

8° | Vertical | 1900 MHz

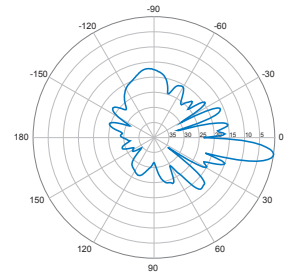

8° | Vertical | 2100 MHz

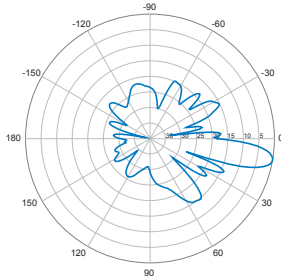

10° | Vertical | 1800 MHz

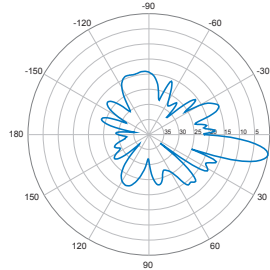

10° | Vertical | 1900 MHz

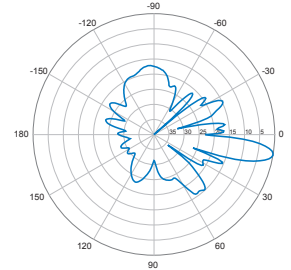

10° | Vertical | 2100 MHz

Quoted performance parameters are provided to offer typical, peak or range values only and may vary as a result of normal testing, manufacturing and operational conditions. Extreme operational conditions and/or stress on structural supports is beyond our control. Such conditions may result in damage to this product. Improvements to products may be made without notice.

## HEX334CW0000x

TRI BAND | HEX PORT | PANEL ANTENNA | XXX-POL | 33° / 33° / 33° | 15.3 / 18.0 / 18.0 DBI | VARIABLE TILT

### Antenna Ordering Options

Select Electrical Tilt Type	Actuator Description	Select RET Actuator Port Configuration		Antenna Model Number
		Port A	Port B	
Manual Electrical Tilt	---	---	---	HEX334CW0000 <b>0M</b>
Remote Electrical Tilt AISG v2.0 / 3GPP with an <b>MDCU</b> RET Actuator	The <b>MDCU</b> (Multi-Device Control Unit) is an electronic module that allows the remote control of the electrical downtilt (RET) in Amphenol antennas with factory embedded motors. The MDCU is factory installed.	---	---	HEX334CW0000 <b>0G</b>
Remote Electrical Tilt AISG v2.0 / 3GPP with an <b>MDDU</b> RET Actuator	The <b>MDDU</b> (Multi-Device Dual Unit) allows two separate RET Controllers to independently drive the RETs in Amphenol antennas with factory installed motors (for antenna sharing). The MDDU is factory installed.	Red 696-960 MHz	White / Blue 1695-2180 / 1695-2180 MHz	HEX334CW0000 <b>0L</b>
		Blue 1695-2180 MHz	White / Red 1695-2180 / 696-960 MHz	HEX334CW0000 <b>L1</b>
		White 1695-2180 MHz	Blue / Red 1695-2180 / 696-960 MHz	HEX334CW0000 <b>L2</b>

### Mounting Kit Ordering Options All mounting bracket kits are ordered separately unless otherwise indicated.

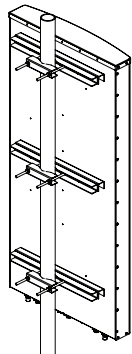
Mounting Options	Part Number	Image	Fits Pipe Diameter	Weight
3-Point Mounting Bracket Kit <i>Antenna cannot be mechanically downtilted.</i>	MKS09P04		50-115 mm 2.0-4.5 in	14.5 kg 32 lbs

Quoted performance parameters are provided to offer typical, peak or range values only and may vary as a result of normal testing, manufacturing and operational conditions. Extreme operational conditions and/or stress on structural supports is beyond our control. Such conditions may result in damage to this product. Improvements to products may be made without notice.