

## AASBC-131

1800 MHz | Same Band Combiner | AISG and DC Transparency | Single Unit

- 1800 MHz, antenna sharing filter
- AISG and DC transparency
- Helps to minimize site acquisition issues
- Reduces the cost of network expansion

**NO  
IMAGE  
AVAILABLE**

**COMING  
SOON**

RF Characteristics			
Uplink (Rx) Path		Low	High
Frequency Band		1710-1740 MHz	1770-1785 MHz
Insertion Loss		< 0.3 dB	< 0.6 dB
Downlink (Tx) Path		Low	High
Frequency Band		1805-1835 MHz	1865-1880 MHz
Insertion Loss		< 0.4 dB	< 0.5 dB
Continuous Average Power	Average (53 dBm)	200 W	
	Peak (57 dBm)	500 W	
Intermodulation (2x43 dBm TX carrier, BTS Port)		-160 dBc	
All Bands			
Return Loss		18 dB	
Isolation Between Node B Ports	at Rx Frequency	20 dB	
	at Tx Frequency	35 dB	
Power Supply			
AISG Signal Attenuation at 2.176 GHz		< 1 dB	
Voltage Drop (maximum at 10-30 VDC)		1 V	
Supply Voltage Handling		0-32 VDC	
Continuous Current Handling		5A, 0-32 VDC	
AISG / DC Transparency Between Ports		High to Common	
Environmental Characteristics			
Operating Temperature Range		-10° to +65° C (+14° to +149° F)	
Operation		ETS 300 019-1-4 Class 4.2H	
Storage		ETS 300 019-1-1	
Ingress Protection		IP67	
EMC		EN 301 489-8	
Safety Standards		EN 60950	
MTBF		1.5 M hours	
Lightning Protection		3 kA 10/350 μs, 10 kA 8/20 μs	

Quoted performance parameters are provided to offer typical or range values only and may vary as a result of normal manufacturing and operational conditions. Extreme operational conditions and/or stress on structural supports is beyond our control. Such conditions may result in damage to this product. Improvements to product may be made without notice.

## AASBC-131

1800 MHz | Same Band Combiner | AISG and DC Transparency | Single Unit

Mechanical Characteristics		
Dimensions - Length x Width x Depth	262 x 177 x 55 mm	10.3 x 7.0 x 2.2 in
Connectors (number, type)	3 Connectors / 7-16 Female	
Block Diagram		

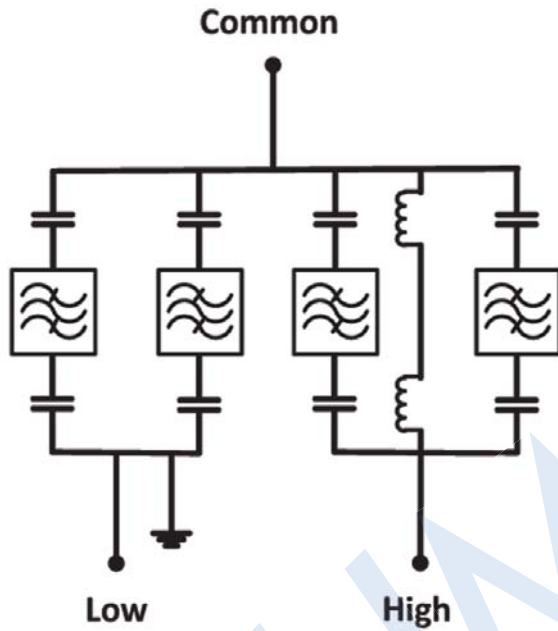

Quoted performance parameters are provided to offer typical or range values only and may vary as a result of normal manufacturing and operational conditions. Extreme operational conditions and/or stress on structural supports is beyond our control. Such conditions may result in damage to this product. Improvements to product may be made without notice.