

7478000 • 7478200

Single Band | Shrouded Yagi Antenna | V-Pol | 48°-78° | 9.5-12.0 dBi

Ordering Options		Model Number				
Antenna with N-Type Connector		7478000				
Antenna with 7/16-DIN Connector		7478200				
Electrical Characteristics		690-2700 MHz				
Frequency Band		700 MHz	900 MHz	1800 MHz	2100 MHz	2700 MHz
Polarization		Vertical				
Horizontal Beamwidth (-3 dB)		53°	50°	48°	62°	78°
Vertical Beamwidth (-3 dB)		46°	45°	40°	40°	38°
Gain		11.0 dBi	12.0 dBi	11.6 dBi	11.0 dBi	9.5 dBi
VSWR		< 1.5:1				
Front-to-Back Ratio		> 25 dB Typical				
Passive Intermodulation (2x20W carriers)	7478000	< -143 dBc				
	7478200	< -153 dBc				
Input Power		150 W				
Connector(s)		N-Type Female or 7/16-DIN Female / Rear of the Mounting Tube				
Mechanical Characteristics						
Dimensions (Length x Diameter)		1335 x Ø180 mm (52.5 x Ø7.0 in)				
Weight without Bracket		7.0 kg (15.4 lbs)				
Survival Wind Speed		200 km/hr (125 mph)				
Wind Load (160 km/hr or 100 mph)		250 N (56 lbf)				
Mounting Options						
Mounting requires Cross-Over Casting and U-Bolt to match mounting mast diameter. See options below.						
Cross-Over Casting		0300284/00				
U-Bolt (2-inch)		4884036/00				
U-Bolt (3-inch)		4884076/00				
U-Bolt (4-inch)		4884035/00				
Optional Wall Mount, Front Support		0900911/00				
Optional Wall Mount, Rear Support		XSL9255121				
Tunnel Mount Kit (Front and Rear)		XSL9254928				

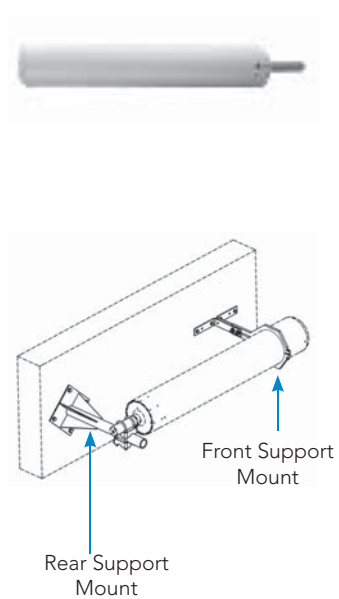

Quoted performance parameters are provided to offer typical or range values only and may vary as a result of normal manufacturing and operational conditions. Extreme operational conditions and/or stress on structural supports is beyond our control. Such conditions may result in damage to this product. Improvements to product may be made without notice.

7478000 • 7478200

Single Band | Log Periodic | V-Pol | 48°-78° | 9.5-12.0 dBi

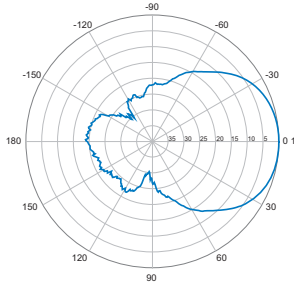

Horizontal | 700 MHz

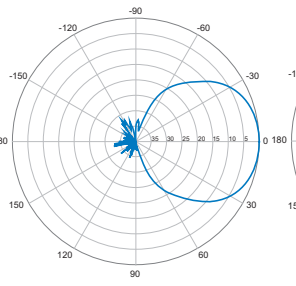

Horizontal | 900 MHz

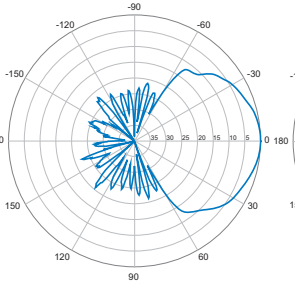

Horizontal | 1800 MHz

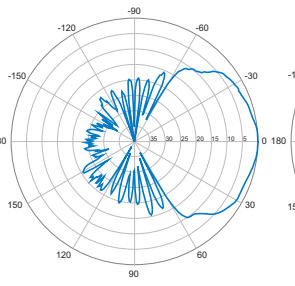

Horizontal | 2100 MHz

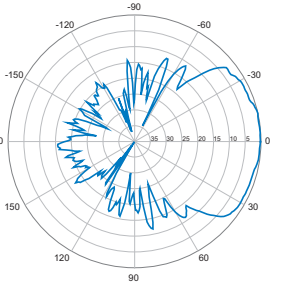

Horizontal | 2700 MHz

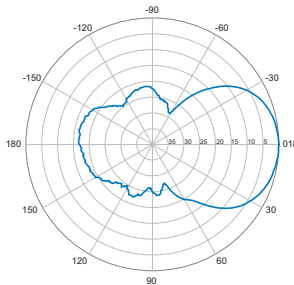

Vertical | 700 MHz

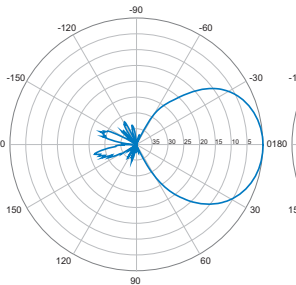

Vertical | 900 MHz

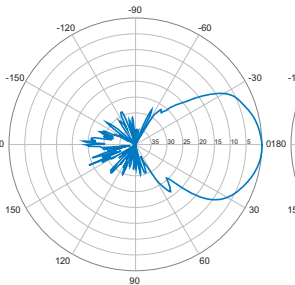

Vertical | 1800 MHz

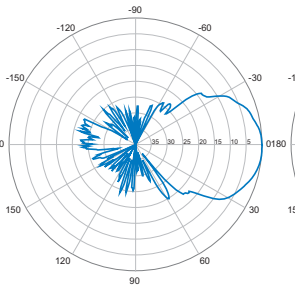

Vertical | 2100 MHz

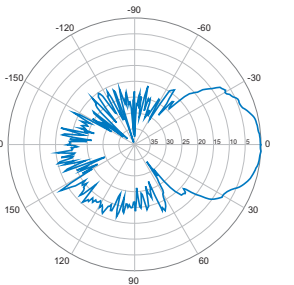

Vertical | 2700 MHz

Quoted performance parameters are provided to offer typical or range values only and may vary as a result of normal manufacturing and operational conditions. Extreme operational conditions and/or stress on structural supports is beyond our control. Such conditions may result in damage to this product. Improvements to product may be made without notice.