

## CUT070X06Fxyz1

DUAL BAND | DIPLEXED | 3-SECTOR, CLOVER-SHAPE | CANISTER ANTENNA | X-POL | FIXED TILT | 610 MM (24.0 IN)

### Features

- Diplexed, 3-Sector, Clover-Shape configuration with 6 connectors
- Ideal for Small Cell / DAS applications
- Available with 4.3/10 or 7/16-DIN connectors
- Four unique mounting options
- Available in gray and brown



### Connector Description

The diplexed antenna has 6 connectors located at the bottom.

Low Band ■ R1 / High Band ■ Y1      696-960 / 1695-2700 MHz      (6x) 4.3/10 or 7/16-DIN Female

Electrical Characteristics	Low Band <span style="color: red;">■</span> R1		High Band <span style="color: yellow;">■</span> Y1			
Frequency Bands (MHz)	696-960 MHz		1695-2700 MHz			
	696-806	806-960	1695-1880	1850-1990	1920-2200	2300-2700
Polarization	±45°		±45°			
Horizontal Beamwidth	70°	65°	70°	68°	65°	63°
Vertical Beamwidth	35°	30°	17°	16°	15°	14°
Gain	8.7 dBi	9.7 dBi	12.7 dBi	13.2 dBi	13.7 dBi	14.0 dBi
Electrical Downtilt (°)	(x) 0, 5		(y) 0, 6			
Impedance	50Ω		50Ω			
VSWR	≤ 1.5:1		≤ 1.5:1			
Upper Sidelobe Suppression	> 15 dB		> 15 dB			
Front-to-Back Ratio	> 30 dB		> 30 dB			
Isolation Between Ports	20 dB		22 dB			
IM3 (2x20W carrier)	< -153 dBc		< -153 dBc			
Input Power	(3x) 500 W		(3x) 300 W			
Diplexed	Yes (Internal Diplexer)					
Number of Sectors, Sector Spacing and/or Pattern Shape	3 Sectors, 120° Spacing, Clover-Shape					
Lightning Protection	Direct Ground					

### Mechanical Characteristics

Antenna Dimensions (Height x Diameter)	610 x 371 mm	24.0 x 14.6 in
Weight without Mounting Bracket Kit	10.0 kg	22.0 lbs
Antenna Volume	0.07 m <sup>3</sup>	2.3 ft <sup>3</sup>
Survival Wind Speed	200 km/hr	125 mph
Wind Area	0.22 m <sup>2</sup>	2.4 ft <sup>2</sup>
Wind Load (160 km/hr or 100 mph)	191 N	43 lbf

Quoted performance parameters are provided to offer typical, peak or range values only and may vary as a result of normal testing, manufacturing and operational conditions. Extreme operational conditions and/or stress on structural supports is beyond our control. Such conditions may result in damage to this product. Improvements to products may be made without notice.

### CUT070X06Fxyz1

DUAL BAND | DIPLEXED | 3-SECTOR, CLOVER-SHAPE | CANISTER ANTENNA | X-POL | FIXED TILT | 610 MM (24.0 IN)

#### Bottom View - Labeling

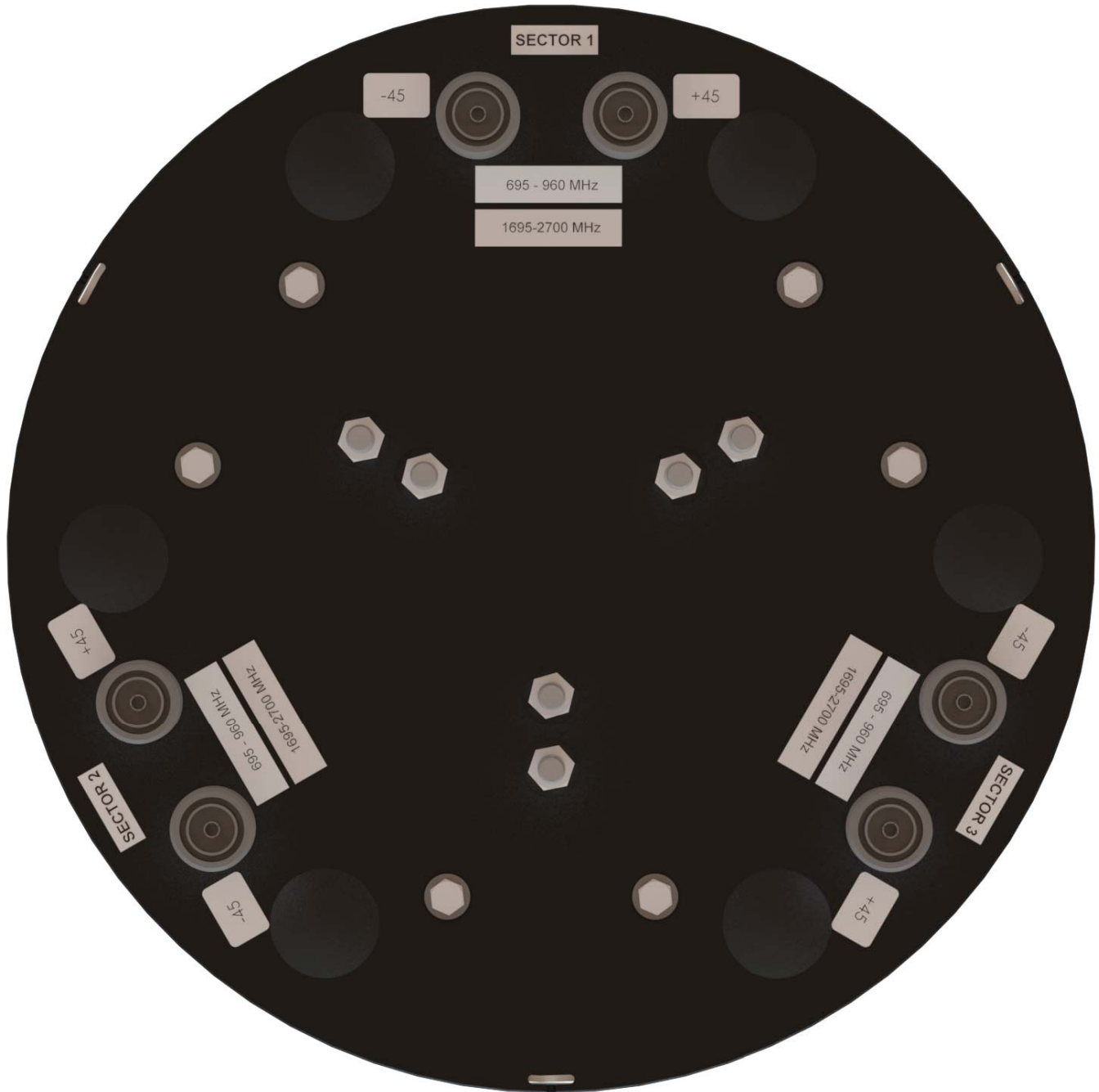

Quoted performance parameters are provided to offer typical, peak or range values only and may vary as a result of normal testing, manufacturing and operational conditions. Extreme operational conditions and/or stress on structural supports is beyond our control. Such conditions may result in damage to this product. Improvements to products may be made without notice.

CUT070X06Fxyz1

DUAL BAND | DIPLEXED | 3-SECTOR, CLOVER-SHAPE | CANISTER ANTENNA | X-POL | FIXED TILT | 610 MM (24.0 IN)

Bottom View -  
Connector Diagram

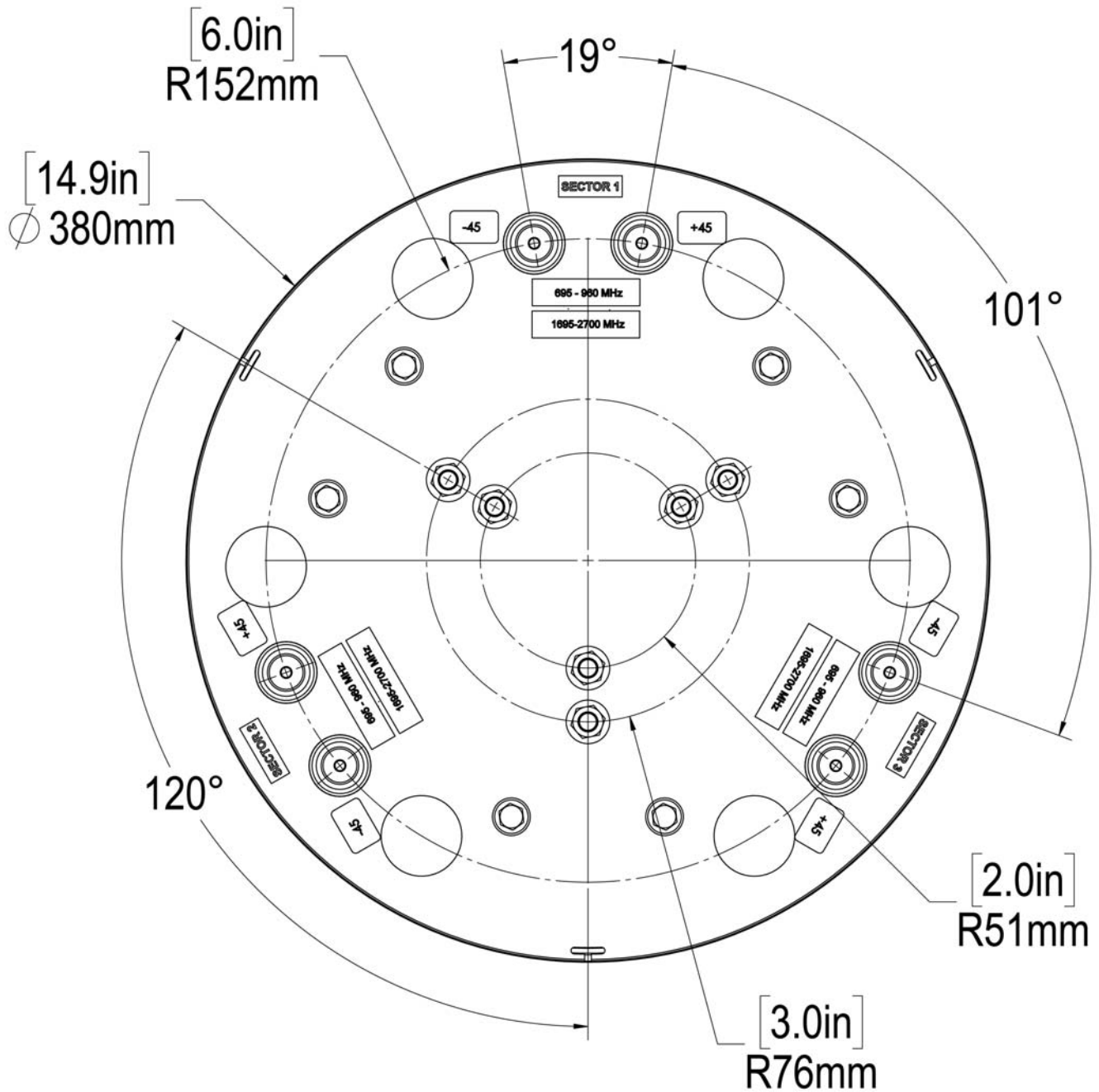

Quoted performance parameters are provided to offer typical, peak or range values only and may vary as a result of normal testing, manufacturing and operational conditions. Extreme operational conditions and/or stress on structural supports is beyond our control. Such conditions may result in damage to this product. Improvements to products may be made without notice.

CUT070X06Fxyz1

DUAL BAND | DIPLEXED | 3-SECTOR, CLOVER-SHAPE | CANISTER ANTENNA | X-POL | FIXED TILT | 610 MM (24.0 IN)

696-960 MHz

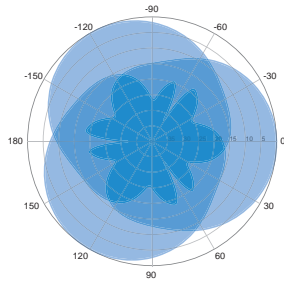

Horizontal | 750 MHz

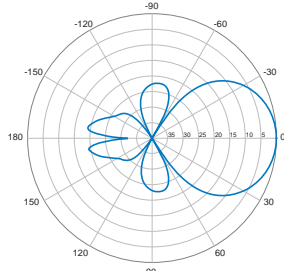

0° | Vertical | 750 MHz

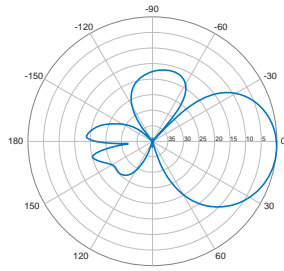

5° | Vertical | 750 MHz

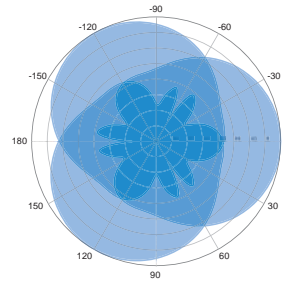

Horizontal | 850 MHz

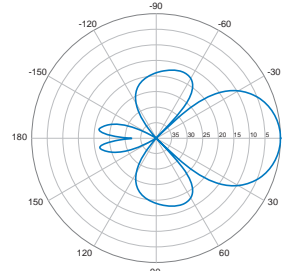

0° | Vertical | 850 MHz

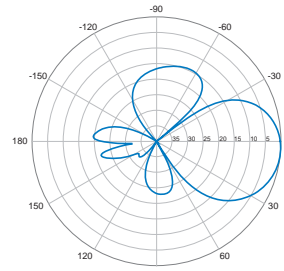

5° | Vertical | 850 MHz

Quoted performance parameters are provided to offer typical, peak or range values only and may vary as a result of normal testing, manufacturing and operational conditions. Extreme operational conditions and/or stress on structural supports is beyond our control. Such conditions may result in damage to this product. Improvements to products may be made without notice.

CUT070X06Fxyz1

DUAL BAND | DIPLEXED | 3-SECTOR, CLOVER-SHAPE | CANISTER ANTENNA | X-POL | FIXED TILT | 610 MM (24.0 IN)

1695-2700 MHz

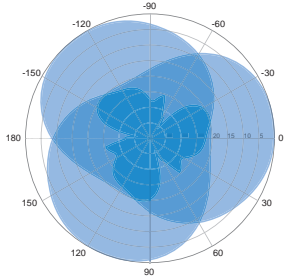

Horizontal | 1800 MHz

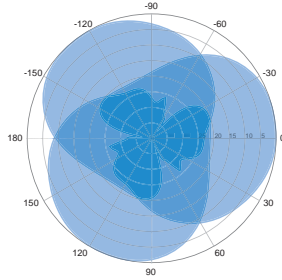

Horizontal | 1900 MHz

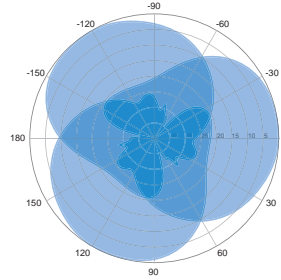

Horizontal | 2100 MHz

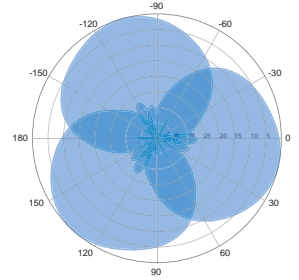

Horizontal | 2600 MHz

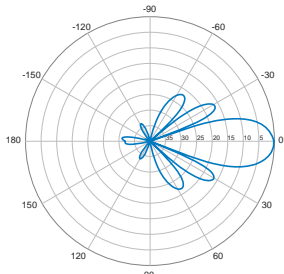

0° | Vertical | 1800 MHz

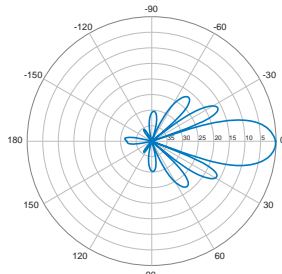

0° | Vertical | 1900 MHz

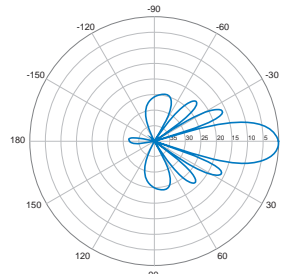

0° | Vertical | 2100 MHz

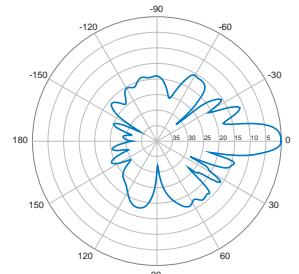

0° | Vertical | 2600 MHz

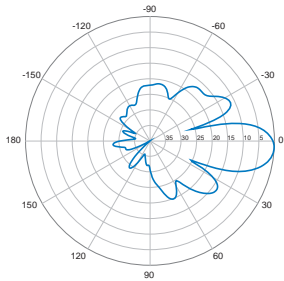

6° | Vertical | 1800 MHz

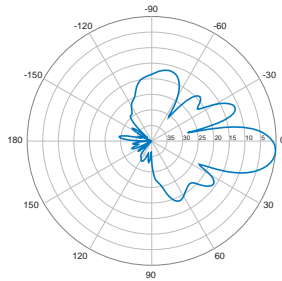

6° | Vertical | 1900 MHz

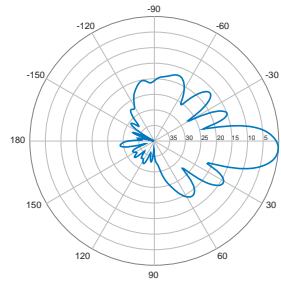

6° | Vertical | 2100 MHz

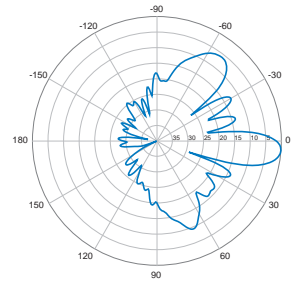

6° | Vertical | 2600 MHz

Quoted performance parameters are provided to offer typical, peak or range values only and may vary as a result of normal testing, manufacturing and operational conditions. Extreme operational conditions and/or stress on structural supports is beyond our control. Such conditions may result in damage to this product. Improvements to products may be made without notice.

## CUT070X06Fxyz1

DUAL BAND | DIPLEXED | 3-SECTOR, CLOVER-SHAPE | CANISTER ANTENNA | X-POL | FIXED TILT | 610 MM (24.0 IN)





### Ordering Options

When ordering, select the Paint Color, Degree of Electrical Downtilt (**xy**) for the Low and High Bands and the Connector Type (**z**).

Paint Color	Electrical Downtilt Degree		Connector Type ( <b>z</b> )	
	Low Band ( <b>x</b> )	High Band ( <b>y</b> )	4.3/10 Female	7/16-DIN Female
Painted Gray	0°	0°	CUT070X06F <b>00s</b> 1	CUT070X06F <b>00D</b> 1
	0°	6°	CUT070X06F <b>06s</b> 1	CUT070X06F <b>06D</b> 1
	5°	0°	CUT070X06F <b>50s</b> 1	CUT070X06F <b>50D</b> 1
	5°	6°	CUT070X06F <b>56s</b> 1	CUT070X06F <b>56D</b> 1
Painted Brown	0°	0°	CUT070X06F <b>00s</b> 1BR	CUT070X06F <b>00D</b> 1BR
	0°	6°	CUT070X06F <b>06s</b> 1BR	CUT070X06F <b>06D</b> 1BR
	5°	0°	CUT070X06F <b>50s</b> 1BR	CUT070X06F <b>50D</b> 1BR
	5°	6°	CUT070X06F <b>56s</b> 1BR	CUT070X06F <b>56D</b> 1BR

### Mounting Kits

This antenna can be mounted using any of the following mounting kits. Mounting kits must be ordered separately.

Side Mounting Bracket Kit	Top Mounting Bracket Kit	Utility Pole Mounting Bracket Kit	Wide Diameter Pole Top Mounting Bracket Kit
CWT-MKS-SIDE	CWT-MKS-TOP	WB3X-MKS-01	CWT-MKS-BASE-xx
			

Quoted performance parameters are provided to offer typical, peak or range values only and may vary as a result of normal testing, manufacturing and operational conditions. Extreme operational conditions and/or stress on structural supports is beyond our control. Such conditions may result in damage to this product. Improvements to products may be made without notice.